

QUAFLUX

FLOOR DRAINERS

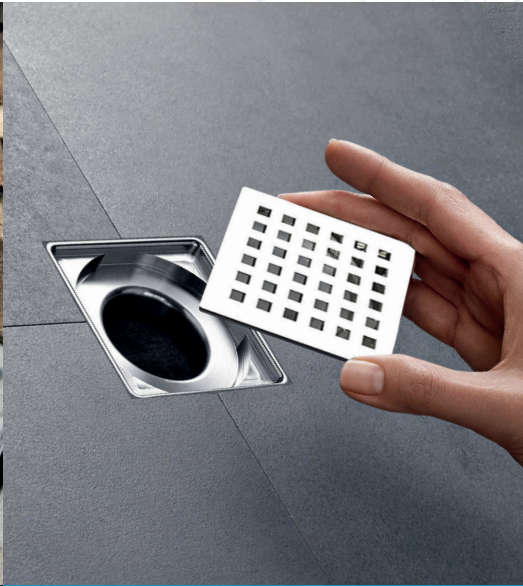

DRENAJ KANALI



YER SIFONLARI



DUŞ KANALLARI

we care your bathroom

KALİTELİ VE BAŞARILI ÇALIŞMALAR 22 YILDIR...

Quaflux is a  **FURKAN GROUP** ' brand.
"WE PRODUCE FOR YOU"

www.quaflux.com

HAKKIMIZDA

QUAFLUX;

Sayın Muharrem ÇETİN tarafından 2001 yılında kurulan firmamız sizlere her zaman hoşgörü ve saygı çerçevesinde büyük bir özen, itina ve dürüstlikle hizmet vermiştir. FURKAN GROUP günümüzün ilerleyen teknolojisi ile hızla büyümüş ve Türkiye’de birçok sektöre üretim yapabilen ender firmalar arasında yerini almıştır.

Gerek üretim tesislerimizde gerekse uzman ekibimiz ile hızlı, girişimci ve yeni özgün fikirler geliştirerek AR-GE çalışmalarına üretime ara vermeden devam etmektedir.

Yurt içinde ve yurt dışında yaptığı çalışmalarla hedefi her zaman kendisine ve müşterilerine üstün kalite olan firmamız, en son yeniliklerle sektörüne katma değer katmaktadır.

“Üretimde başarı ve sürekliliğin teminatı hizmette dürüstlük ve kalitedir” prensibiyle çalışan firmamız yeniliklerle sektörüne hizmet etmeye devam etmektedir.

22 YILDIR KALİTELİ VE BAŞARILI İŞLER...

Saygılar.

KALİTELİ VE BAŞARILI ÇALIŞMALAR
40 YILDIR

Türkiye





QUAFLUX

FLOOR DRAINERS



SKYLINE

Plastik Gvde / Paslanmaz Kapak

304 | STAINLESS
STEEL

www.quaflux.com

AURA + PLUS SERIES
SKYLINE

- Banyo Duşu
- Hastane Duşu
- Otel Duşu
- Soyunma Odası Duşu

- *Plastik Gövde
- *Paslanmaz Izgara
- *Su ile Koku Engelleme



Kod	Boyut	Çıkış		Hammaddeler
Skl 1001	20 cm Yatay Çıkış	Ø 50	12	Polipropilen / Paslanmaz
Skl1002	30 cm Yatay Çıkış	Ø 50	12	Polipropilen / Paslanmaz
Skl 1003	40 cm Yatay Çıkış	Ø 50	12	Polipropilen / Paslanmaz
Skl 1004	50 cm Yatay Çıkış	Ø 50	12	Polipropilen / Paslanmaz
Skl 1005	60 cm Yatay Çıkış	Ø 50	12	Polipropilen / Paslanmaz
Skl 1006	80 cm Yatay Çıkış	Ø 50	12	Polipropilen / Paslanmaz

IZGARA DESEN SEÇENEKLERİ

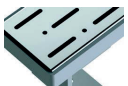

RAIN

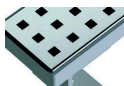

KARE

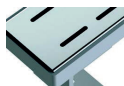

LINE

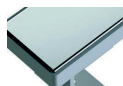

DOLU

ÇIKIŞ SEÇENEKLERİ



1250



1251



1252



1253



1254



1255



1256



1257



1258

QUAFLUX

FLOOR DRAINERS



SKY - ELİPS

Plastik Gvde / Paslanmaz Kapak

304 | STAINLESS
STEEL

www.quaflux.com

AURA + PLUS SERIES
SKY - ELİPS

- Banyo Duşu
- Hastane Duşu
- Otel Duşu
- Soyunma Odası Duşu

- *Plastik Gövde
- *Paslanmaz Izgara
- *Su ile Koku Engelleme

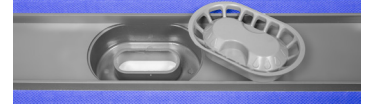

Kod	Boyut	Çıkış		Hammaddeler
Ske 1001	20 cm Yatay Çıkış	Ø 50	12	Polipropilen / Paslanmaz
Ske 1002	30 cm Yatay Çıkış	Ø 50	12	Polipropilen / Paslanmaz
Ske 1003	40 cm Yatay Çıkış	Ø 50	12	Polipropilen / Paslanmaz
Ske 1004	50 cm Yatay Çıkış	Ø 50	12	Polipropilen / Paslanmaz
Ske 1005	60 cm Yatay Çıkış	Ø 50	12	Polipropilen / Paslanmaz
Ske 1006	70 cm Yatay Çıkış	Ø 50	12	Polipropilen / Paslanmaz
Ske 1007	80 cm Yatay Çıkış	Ø 50	12	Polipropilen / Paslanmaz

İZGARA DESEN SEÇENEKLERİ

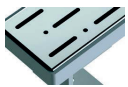

RAIN



KARE

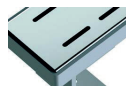

LINE

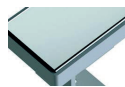

DOLU

ÇIKIŞ SEÇENEKLERİ



1260



1261



1262



1263



1264

QUAFLUX

FLOOR DRAINERS



SKY - PROOF

Plastik Gvde / Paslanmaz Kapak

304 | STAINLESS
STEEL

www.quaflux.com

AURA + PLUS SERIES
SKY - PROOF

- Banyo Duşu
- Hastane Duşu
- Otel Duşu
- Soyunma Odası Duşu

- *Plastik Gövde
- *Paslanmaz Izgara
- *Su ile Koku Engelleme

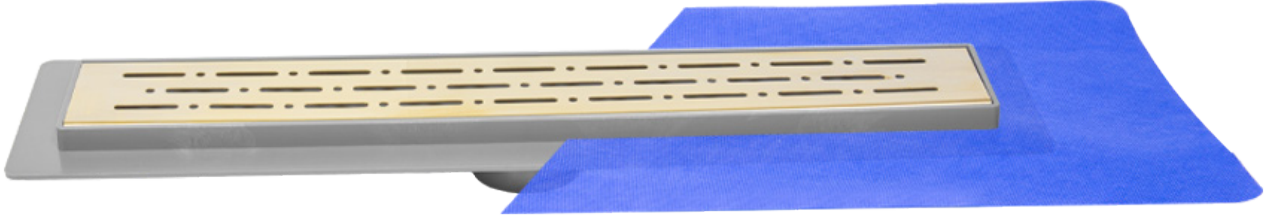

Kod	Boyut	Çıkış		Hammaddeler
SP 1001	20 cm Yatay Çıkış	Ø 50	12	Polipropilen / Paslanmaz
SP 1002	30 cm Yatay Çıkış	Ø 50	12	Polipropilen / Paslanmaz
SP 1003	40 cm Yatay Çıkış	Ø 50	12	Polipropilen / Paslanmaz
SP 1004	50 cm Yatay Çıkış	Ø 50	12	Polipropilen / Paslanmaz
SP 1005	60 cm Yatay Çıkış	Ø 50	12	Polipropilen / Paslanmaz
SP 1006	70 cm Yatay Çıkış	Ø 50	12	Polipropilen / Paslanmaz
SP 1007	80 cm Yatay Çıkış	Ø 50	12	Polipropilen / Paslanmaz

IZGARA DESEN SEÇENEKLERİ

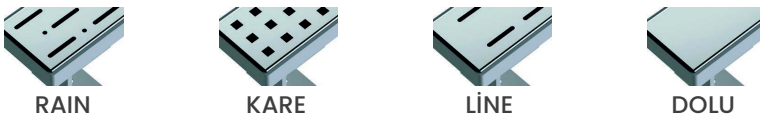

ÇIKIŞ SEÇENEKLERİ

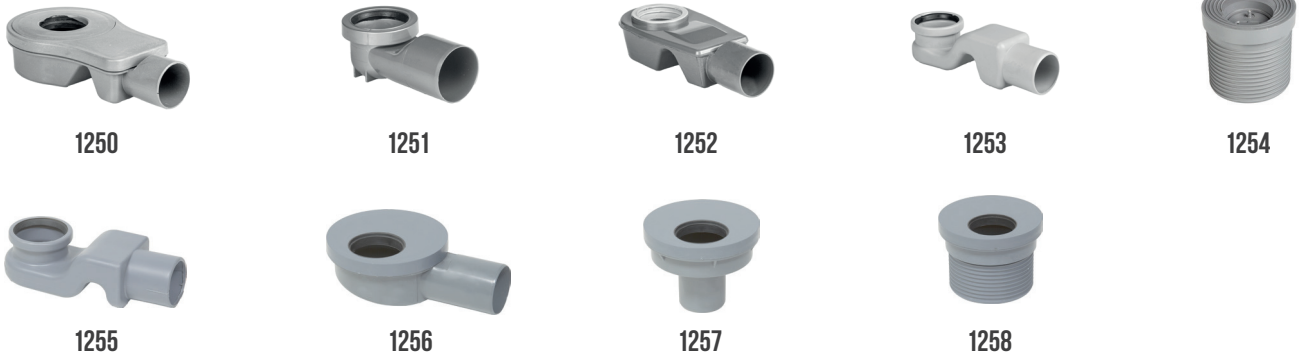

QUAFLUX

FLOOR DRAINERS



SKY - PROOF - ELİPS

Plastik Gvde / Paslanmaz Kapak

304 | STAINLESS
STEEL

www.quaflux.com

AURA + PLUS SERIES
SKY - PROOF - ELİPS

- Banyo Duşu
- Hastane Duşu
- Otel Duşu
- Soyunma Odası Duşu

- *Plastik Gövde
- *Paslanmaz Izgara
- *Su ile Koku Engelleme

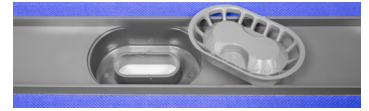
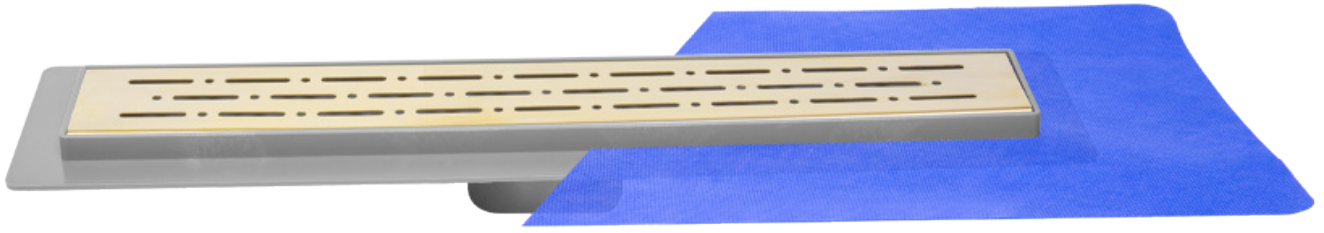

Kod	Boyut	Çıkış		Hammaddeler
SPE 1001	20 cm Yatay Çıkış	Ø 50	12	Polipropilen / Paslanmaz
SPE 1002	30 cm Yatay Çıkış	Ø 50	12	Polipropilen / Paslanmaz
SPE 1003	40 cm Yatay Çıkış	Ø 50	12	Polipropilen / Paslanmaz
SPE 1004	50 cm Yatay Çıkış	Ø 50	12	Polipropilen / Paslanmaz
SPE 1005	60 cm Yatay Çıkış	Ø 50	12	Polipropilen / Paslanmaz
SPE 1006	70 cm Yatay Çıkış	Ø 50	12	Polipropilen / Paslanmaz
SPE 1007	80 cm Yatay Çıkış	Ø 50	12	Polipropilen / Paslanmaz

IZGARA DESEN SEÇENEKLERİ

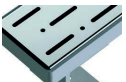

RAIN

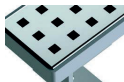

KARE

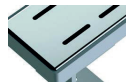

LİNE

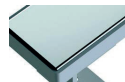

DOLU

ÇIKIŞ SEÇENEKLERİ



1260



1261



1262



1263



1264

QUAFLUX

FLOOR DRAINERS



SIMPLE - LINE

Plastik Gvde / Paslanmaz Kapak

304 | STAINLESS
STEEL

www.quaflux.com

AURA + PLUS SERIES

**SİMPLE
LINE**

- Banyo Duşu
- Hastane Duşu
- Otel Duşu
- Soyunma Odası Duşu

- *Plastik Gövde
- *Paslanmaz Izgara
- *Su ile Koku Engelleme



Kod	Boyut	Çıkış		Hammaddeler
SML 1001	20 cm Yatay Çıkış	Ø 50	12	Polipropilen / Paslanmaz
SML 1002	33 cm Yatay Çıkış	Ø 50	12	Polipropilen / Paslanmaz
SML 1003	40 cm Yatay Çıkış	Ø 50	12	Polipropilen / Paslanmaz
SML 1004	50 cm Yatay Çıkış	Ø 50	12	Polipropilen / Paslanmaz
SML 1005	60 cm Yatay Çıkış	Ø 50	12	Polipropilen / Paslanmaz
SML 1006	80 cm Yatay Çıkış	Ø 50	12	Polipropilen / Paslanmaz



Kod	Boyut	Çıkış		Hammaddeler
SML 1001	20 cm Yatay Çıkış	Ø 50	12	Polipropilen / Paslanmaz
SML 1002	33 cm Yatay Çıkış	Ø 50	12	Polipropilen / Paslanmaz
SML 1003	40 cm Yatay Çıkış	Ø 50	12	Polipropilen / Paslanmaz
SML 1004	50 cm Yatay Çıkış	Ø 50	12	Polipropilen / Paslanmaz
SML 1005	60 cm Yatay Çıkış	Ø 50	12	Polipropilen / Paslanmaz
SML 1006	80 cm Yatay Çıkış	Ø 50	12	Polipropilen / Paslanmaz

IZGARA DESEN SEÇENEKLERİ



RAIN

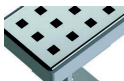

KARE

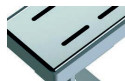

LINE

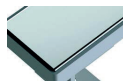

DOLU

QUAFLUX

FLOOR DRAINERS



SİMPLE - PROOF

Plastik Gvde / Paslanmaz Kapak

304 | STAINLESS
STEEL

www.quaflux.com

AURA + PLUS SERIES

**SIMPLE
PROOF**

- Banyo Duşu
- Hastane Duşu
- Otel Duşu
- Soyunma Odası Duşu

- *Plastik Gövde
- *Paslanmaz Izgara
- *Su ile Koku Engelleme

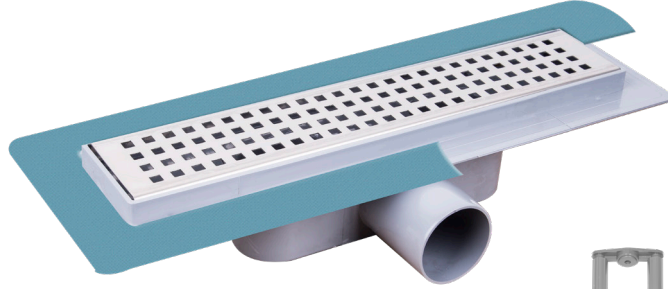

Kod	Boyut	Çıkış		Hammaddeler
SMP 1001	20 cm Yatay Çıkış	Ø 50	12	Polipropilen / Paslanmaz
SMP 1002	33 cm Yatay Çıkış	Ø 50	12	Polipropilen / Paslanmaz
SMP 1003	40 cm Yatay Çıkış	Ø 50	12	Polipropilen / Paslanmaz
SMP 1004	50 cm Yatay Çıkış	Ø 50	12	Polipropilen / Paslanmaz
SMP 1005	60 cm Yatay Çıkış	Ø 50	12	Polipropilen / Paslanmaz
SMP 1006	80 cm Yatay Çıkış	Ø 50	12	Polipropilen / Paslanmaz



Kod	Boyut	Çıkış		Hammaddeler
SMP 1001	20 cm Yatay Çıkış	Ø 50	12	Polipropilen / Paslanmaz
SMP 1002	33 cm Yatay Çıkış	Ø 50	12	Polipropilen / Paslanmaz
SMP 1003	40 cm Yatay Çıkış	Ø 50	12	Polipropilen / Paslanmaz
SMP 1004	50 cm Yatay Çıkış	Ø 50	12	Polipropilen / Paslanmaz
SMP 1005	60 cm Yatay Çıkış	Ø 50	12	Polipropilen / Paslanmaz
SMP 1006	80 cm Yatay Çıkış	Ø 50	12	Polipropilen / Paslanmaz

IZGARA DESEN SEÇENEKLERİ



RAIN

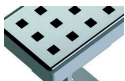

KARE

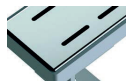

LİNE

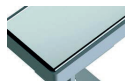

DOLU

QUAFLUX

FLOOR DRAINERS



STONE-S

Paslanmaz Gvde / Paslanmaz Kapak

304 | STAINLESS
STEEL

www.quaflux.com

AURA + PLUS SERIES
STONE-S

- Banyo Duşu
- Hastane Duşu
- Otel Duşu
- Soyunma Odası Duşu

- *Paslanmaz Gövde
- *Paslanmaz Izgara
- *Su ile Koku Engelleme



Kod	Boyut	Çıkış		Hammaddeler
Stns 1001	20 cm Yatay Çıkış	Ø 50	12	Polipropilen / Paslanmaz
Stns 1002	30 cm Yatay Çıkış	Ø 50	12	Polipropilen / Paslanmaz
Stns 1003	40 cm Yatay Çıkış	Ø 50	12	Polipropilen / Paslanmaz
Stns 1004	50 cm Yatay Çıkış	Ø 50	12	Polipropilen / Paslanmaz
Stns 1005	60 cm Yatay Çıkış	Ø 50	12	Polipropilen / Paslanmaz
Stns 1006	70 cm Yatay Çıkış	Ø 50	12	Polipropilen / Paslanmaz

IZGARA DESEN SEÇENEKLERİ

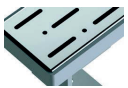

RAIN

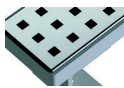

KARE

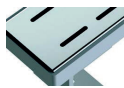

LINE

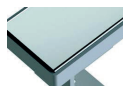

DOLU

ÇIKIŞ SEÇENEKLERİ



1250



1251



1252



1253



1254



1255



1256



1257



1258

QUAFLUX

FLOOR DRAINERS



STONE

Paslanmaz Gvde / Paslanmaz Kapak

304 | STAINLESS
STEEL

www.quaflux.com

AURA + PLUS SERIES
STONE

- Banyo Duşu
- Hastane Duşu
- Otel Duşu
- Soyunma Odası Duşu

- *Paslanmaz Gövde
- *Paslanmaz Izgara
- *Su ile Koku Engelleme



Kod	Boyut	Çıkış		Hammaddeler
Stn 1001	20 cm Yatay Çıkış	Ø 50	12	Polipropilen / Paslanmaz
Stn 1002	30 cm Yatay Çıkış	Ø 50	12	Polipropilen / Paslanmaz
Stn 1003	40 cm Yatay Çıkış	Ø 50	12	Polipropilen / Paslanmaz
Stn1004	50 cm Yatay Çıkış	Ø 50	12	Polipropilen / Paslanmaz
Stn 1005	60 cm Yatay Çıkış	Ø 50	12	Polipropilen / Paslanmaz
Stn 1006	70 cm Yatay Çıkış	Ø 50	12	Polipropilen / Paslanmaz
Stn 1007	80 cm Yatay Çıkış	Ø 50	12	Polipropilen / Paslanmaz

IZGARA DESEN SEÇENEKLERİ

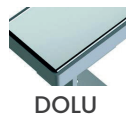

ÇIKIŞ SEÇENEKLERİ



QUAFLUX

FLOOR DRAINERS



STONE-ELİPS

Paslanmaz Gövde / Paslanmaz Kapak

304 | STAINLESS
STEEL

www.quaflux.com

AURA + PLUS SERIES
STONE - ELİPS

- Banyo Duşu
- Hastane Duşu
- Otel Duşu
- Soyunma Odası Duşu

- *Paslanmaz Gövde
- *Paslanmaz Izgara
- *Su ile Koku Engelleme

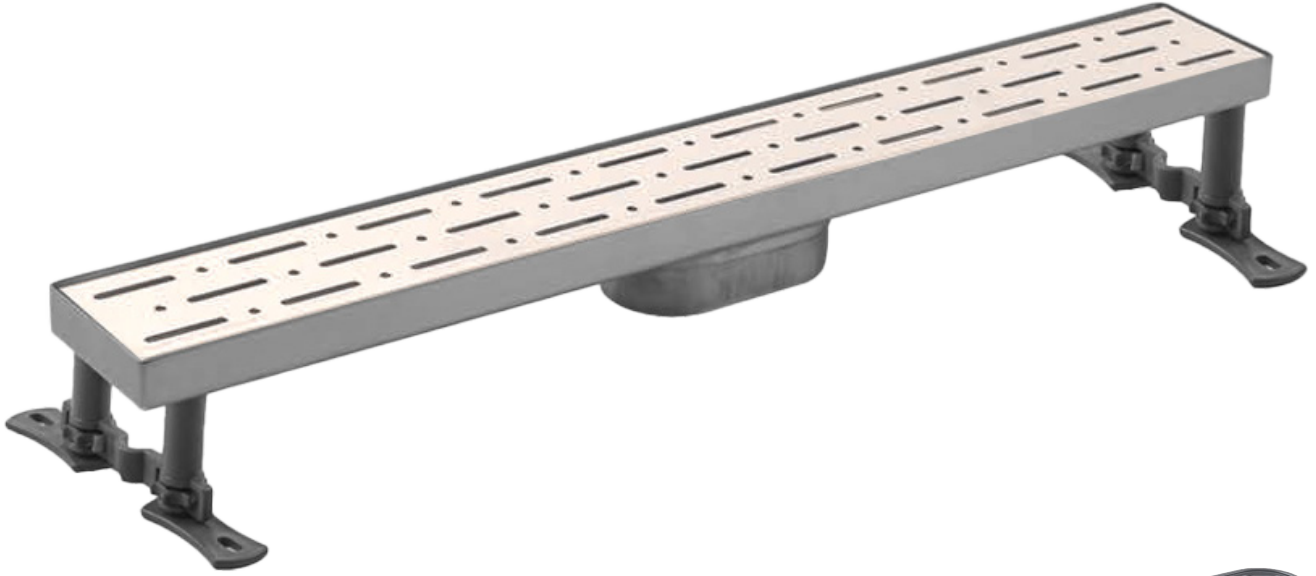

Kod	Boyut	Çıkış		Hammaddeler
SE 1001	20 cm Yatay Çıkış	Ø 50	12	Polipropilen / Paslanmaz
SE 1002	30 cm Yatay Çıkış	Ø 50	12	Polipropilen / Paslanmaz
SE 1003	40 cm Yatay Çıkış	Ø 50	12	Polipropilen / Paslanmaz
SE 1004	50 cm Yatay Çıkış	Ø 50	12	Polipropilen / Paslanmaz
SE 1005	60 cm Yatay Çıkış	Ø 50	12	Polipropilen / Paslanmaz
SE 1006	70 cm Yatay Çıkış	Ø 50	12	Polipropilen / Paslanmaz
SE 1007	80 cm Yatay Çıkış	Ø 50	12	Polipropilen / Paslanmaz

IZGARA DESEN SEÇENEKLERİ

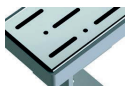

RAIN



KARE

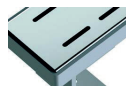

LINE

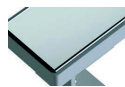

DOLU

ÇIKIŞ SEÇENEKLERİ



1260



1261



1262



1263



1264

QUAFLUX

FLOOR DRAINERS



OMEGA

Paslanmaz Gvde / Paslanmaz Kapak

304 | STAINLESS
STEEL

www.quaflux.com

AURA + PLUS SERIES
OMEGA

- Banyo Duşu
- Hastane Duşu
- Otel Duşu
- Soyunma Odası Duşu

- *Paslanmaz Gövde
- *Paslanmaz Izgara
- *Su ile Koku Engelleme

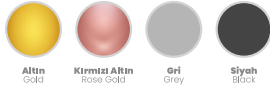

Kod	Boyut	Çıkış		Hammaddeler
Omg 1001	20 cm Yatay Çıkış	Ø 50	12	Polipropilen / Paslanmaz
Omg 1002	30 cm Yatay Çıkış	Ø 50	12	Polipropilen / Paslanmaz
Omg 1003	40 cm Yatay Çıkış	Ø 50	12	Polipropilen / Paslanmaz
Omg 1004	50 cm Yatay Çıkış	Ø 50	12	Polipropilen / Paslanmaz
Omg 1005	60 cm Yatay Çıkış	Ø 50	12	Polipropilen / Paslanmaz
Omg 1006	70 cm Yatay Çıkış	Ø 50	12	Polipropilen / Paslanmaz

IZGARA DESEN SEÇENEKLERİ

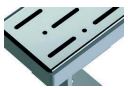

RAIN

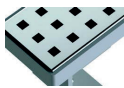

KARE

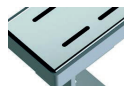

LINE

ÇIKIŞ SEÇENEKLERİ



1250



1251



1252



1253



1254



1255



1256



1257



1258

QUAFLUX

FLOOR DRAINERS



OMEGA - ELİPS

Paslanmaz Gvde / Paslanmaz Kapak

304 | STAINLESS
STEEL

www.quaflux.com

AURA + PLUS SERIES
OMEGA - ELİPS

- Banyo Duşu
- Hastane Duşu
- Otel Duşu
- Soyunma Odası Duşu

- *Paslanmaz Gövde
- *Paslanmaz Izgara
- *Su ile Koku Engelleme



Kod	Boyut	Çıkış		Hammaddeler
Omge1001	20 cm Yatay Çıkış	Ø 50	12	Polipropilen / Paslanmaz
Omge1002	30 cm Yatay Çıkış	Ø 50	12	Polipropilen / Paslanmaz
Omge1003	40 cm Yatay Çıkış	Ø 50	12	Polipropilen / Paslanmaz
Omge1004	50 cm Yatay Çıkış	Ø 50	12	Polipropilen / Paslanmaz
Omge1005	60 cm Yatay Çıkış	Ø 50	12	Polipropilen / Paslanmaz
Omge1006	70 cm Yatay Çıkış	Ø 50	12	Polipropilen / Paslanmaz

IZGARA DESEN SEÇENEKLERİ

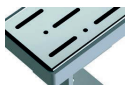

RAIN



KARE

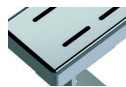

LINE

ÇIKIŞ SEÇENEKLERİ



1260



1261



1262



1263



1264

QUAFLUX

FLOOR DRAINERS



ALFA

Paslanmaz Gvde / Paslanmaz Kapak

304 | STAINLESS
STEEL

www.quaflux.com

AURA+ PLUS SERIES
ALFA

- Banyo Duşu
- Hastane Duşu
- Otel Duşu
- Soyunma Odası Duşu

- *Paslanmaz Gövde
- *Paslanmaz Izgara
- *Su ile Koku Engelleme



Kod	Boyut	Çıkış		Hammaddeler
Alf 1001	20 cm Yatay Çıkış	Ø 50	12	Polipropilen / Paslanmaz
Alf 1002	30 cm Yatay Çıkış	Ø 50	12	Polipropilen / Paslanmaz
Alf 1003	40 cm Yatay Çıkış	Ø 50	12	Polipropilen / Paslanmaz
Alf 1004	50 cm Yatay Çıkış	Ø 50	12	Polipropilen / Paslanmaz
Alf 1005	60 cm Yatay Çıkış	Ø 50	12	Polipropilen / Paslanmaz

IZGARA DESEN SEÇENEKLERİ

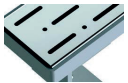

RAIN

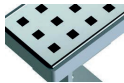

KARE

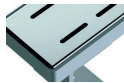

LINE

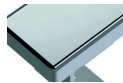

DOLU

ÇIKIŞ SEÇENEKLERİ



1250



1251



1252



1253



1254



1255



1256



1257



1258

QUAFLUX

FLOOR DRAINERS



MASSIVE

Paslanmaz Gvde / Paslanmaz Kapak

304 | STAINLESS
STEEL

www.quaflux.com

AURA + PLUS SERIES
MASSİVE

- Banyo Duşu
- Hastane Duşu
- Otel Duşu
- Soyunma Odası Duşu

- *Paslanmaz Gövde
- *Paslanmaz Izgara
- *Su ile Koku Engelleme

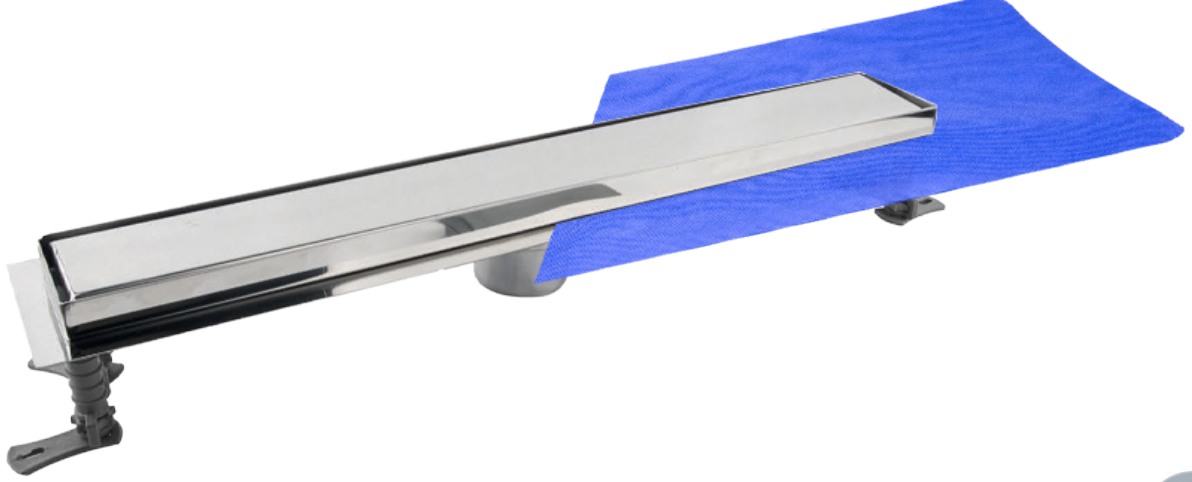

Kod	Boyut	Çıkış		Hammaddeler
Msv 1001	20 cm Yatay Çıkış	Ø 50	12	Polipropilen / Paslanmaz
Msv 1002	30 cm Yatay Çıkış	Ø 50	12	Polipropilen / Paslanmaz
Msv 1003	40 cm Yatay Çıkış	Ø 50	12	Polipropilen / Paslanmaz
Msv 1004	50 cm Yatay Çıkış	Ø 50	12	Polipropilen / Paslanmaz
Msv 1005	60 cm Yatay Çıkış	Ø 50	12	Polipropilen / Paslanmaz
Msv 1006	70 cm Yatay Çıkış	Ø 50	12	Polipropilen / Paslanmaz
Msv 1007	80 cm Yatay Çıkış	Ø 50	12	Polipropilen / Paslanmaz

IZGARA DESEN SEÇENEKLERİ

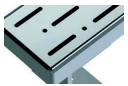

RAIN

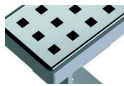

KARE

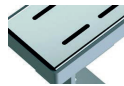

LINE

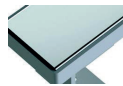

DOLU

ÇIKIŞ SEÇENEKLERİ



1250



1251



1252



1253



1254



1255



1256



1257



1258

QUAFLUX

FLOOR DRAINERS



MASSIVE- ELİPS

Paslanmaz Gvde / Paslanmaz Kapak

304 | STAINLESS
STEEL

www.quaflux.com

AURA + PLUS SERIES

MASSİVE- ELİPS

- Banyo Duşu
- Hastane Duşu
- Otel Duşu
- Soyunma Odası Duşu

- *Paslanmaz Gövde
- *Paslanmaz Izgara
- *Su ile Koku Engelleme

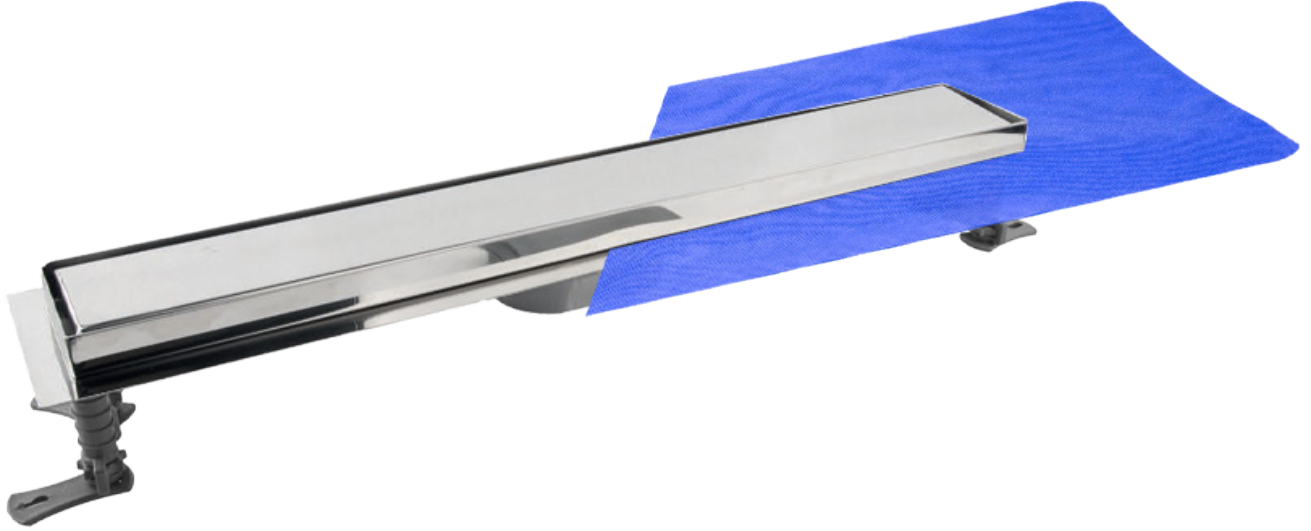

Kod	Boyut	Çıkış		Hammaddeler
Msve 1001	20 cm Yatay Çıkış	Ø 50	12	Polipropilen / Paslanmaz
Msve 1002	30 cm Yatay Çıkış	Ø 50	12	Polipropilen / Paslanmaz
Msve 1003	40 cm Yatay Çıkış	Ø 50	12	Polipropilen / Paslanmaz
Msve 1004	50 cm Yatay Çıkış	Ø 50	12	Polipropilen / Paslanmaz
Msve 1005	60 cm Yatay Çıkış	Ø 50	12	Polipropilen / Paslanmaz
Msve 1006	70 cm Yatay Çıkış	Ø 50	12	Polipropilen / Paslanmaz
Msve 1007	80 cm Yatay Çıkış	Ø 50	12	Polipropilen / Paslanmaz

IZGARA DESEN SEÇENEKLERİ

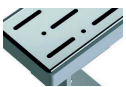

RAIN



KARE

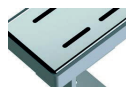

LİNE

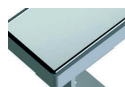

DOLU

ÇIKIŞ SEÇENEKLERİ



1260



1261



1262



1263





1264

VENÜS SERIES

**MAFSALLI
TUTUNMA BARI**

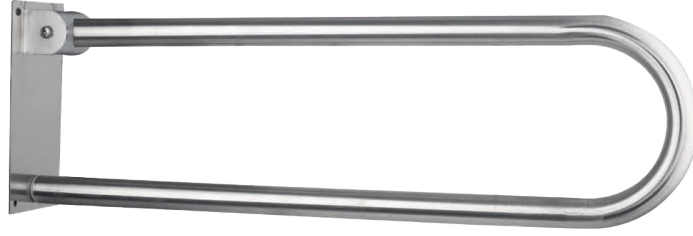
- Banyo Duşu
- Hastane Duşu
- Otel Duşu
- Soyunma Odası Duşu





Kod	Boyut	Çıkış		Hammaddeler
V250230MB	Ø 32 cm	Ø 50	12	Paslanmaz

VENÜS SERIES

**WC MAFSALLI
TUTUNMA
BARI**

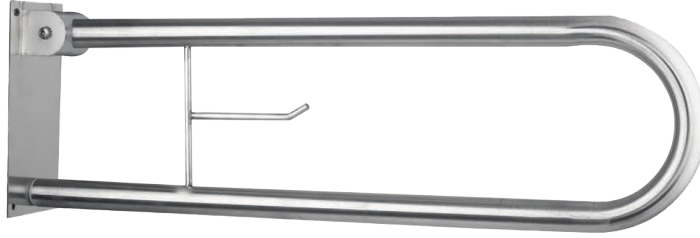
- Banyo Duşu
- Hastane Duşu
- Otel Duşu
- Soyunma Odası Duşu



Kod	Boyut	Çıkış		Hammaddeler
V250230MWB	Ø 32 cm	Ø 50	12	Paslanmaz

VENÜS SERIES

**AYAKLI
MAFSALLI
TUTUNMA BARI**

- Banyo Duşu
- Hastane Duşu
- Otel Duşu
- Soyunma Odası Duşu



Kod	Boyut	Çıkış		Hammaddeler
V250230AMTMB	76 cm Yatay Çıkış	Ø 50	12	Paslanmaz

VENÜS SERIES

YERDEN DUVARA TUTUNMA BARI

- Banyo Duşu
- Hastane Duşu
- Otel Duşu
- Soyunma Odası Duşu



Kod	Boyut	Çıkış		Hammaddeler
V25321YR	Ø 32 cm	Ø 50	12	Paslanmaz

VENÜS SERIES

YERDEN DUVARA DÖNER AYAK TUTUNMA BARI

- Banyo Duşu
- Hastane Duşu
- Otel Duşu
- Soyunma Odası Duşu



Kod	Boyut	Çıkış		Hammaddeler
V25321YRD	Ø 32 cm	Ø 50	12	Paslanmaz

VENÜS SERIES

KÖŞE TUTUNMA BARI

- Banyo Duşu
- Hastane Duşu
- Otel Duşu
- Soyunma Odası Duşu



Kod	Boyut	Çıkış		Hammaddeler
V25322KŞ	Ø 32 cm	Ø 50	12	Paslanmaz

VENÜS SERIES

L TİPİ TUTUNMA BARI

- Banyo Duşu
- Hastane Duşu
- Otel Duşu
- Soyunma Odası Duşu



Kod	Boyut	Çıkış		Hammaddeler
V25323LT	Ø 32 cm	Ø 50	12	Paslanmaz

VENÜS SERIES

AÇILI TUTUNMA BARI

- Banyo Duşu
- Hastane Duşu
- Otel Duşu
- Soyunma Odası Duşu



Kod	Boyut	Çıkış		Hammaddeler
V25324AÇ	Ø 32 cm	Ø 50	12	Paslanmaz

VENÜS SERIES

LAVABO TUTUNMA BARI

- Banyo Duşu
- Hastane Duşu
- Otel Duşu
- Soyunma Odası Duşu



Kod	Boyut	Çıkış		Hammaddeler
V25325LV	Ø 32 cm	Ø 50	12	Paslanmaz

VENÜS SERIES
**ENGELLİ
AYNASI**

50 x 70 cm

- Banyo Duşu
- Hastane Duşu
- Otel Duşu
- Soyunma Odası Duşu



Kod	Boyut	Çıkış		Hammaddeler
V25336EN	50 x 70 cm	Ø 50	12	Paslanmaz

VENÜS SERIES
**KULPLU
ENGELLİ
AYNASI**

50 x 70 cm

- Banyo Duşu
- Hastane Duşu
- Otel Duşu
- Soyunma Odası Duşu



Kod	Boyut	Çıkış		Hammaddeler
V25327KEN	50 x 70 cm	Ø 50	12	Paslanmaz

VENÜS SERIES

**TUTUNMA
BARI**

30 / 40 / 50 / 60

- Banyo Duşu
- Hastane Duşu
- Otel Duşu
- Soyunma Odası Duşu



Kod	Boyut	Çıkış		Hammaddeler
V2530TB	30 cm Yatay Çıkış	Ø 50	12	Paslanmaz
V2540TB	40 cm Yatay Çıkış	Ø 50	12	Paslanmaz
V2550TB	50 cm Yatay Çıkış	Ø 50	12	Paslanmaz
V2560TB	60 cm Yatay Çıkış	Ø 50	12	Paslanmaz

VENÜS SERIES

**PASLANMAZ
MAT SIVI
SABUNLUK**

500 ML- 1000 ML

- Banyo Duşu
- Hastane Duşu
- Otel Duşu
- Soyunma Odası Duşu



Kod	Boyut	Çıkış		Hammaddeler
V24500SAM	500 ML	Ø 50	12	Paslanmaz
V241000SAM	1000 ML	Ø 50	12	Paslanmaz

VENÜS SERIES

**PASLANMAZ
PARLAK SIVI
SABUNLUK**

500 ML - 1000 ML

- Banyo Duşu
- Hastane Duşu
- Otel Duşu
- Soyunma Odası Duşu



Kod	Boyut	Çıkış		Hammaddeler
V24500SAP	500 ML	Ø 50	12	Paslanmaz
V241000SAP	1000 ML	Ø 50	12	Paslanmaz

VENÜS SERIES

**ANKASTRE
SIVI
SABUNLUK**

21 cm

- Banyo Duşu
- Hastane Duşu
- Otel Duşu
- Soyunma Odası Duşu



Kod	Boyut	Çıkış		Hammaddeler
V2421ASS	21cm Dikey Çıkış	Ø 50	20	Paslanmaz

QUAFLUX

FLOOR DRAINERS



YER SIFONLARI

we care your bathroom

www.quaflux.com

Venüs Series

we care your bathroom

Şimdi altın renk seçeneği ile

Venüs Series

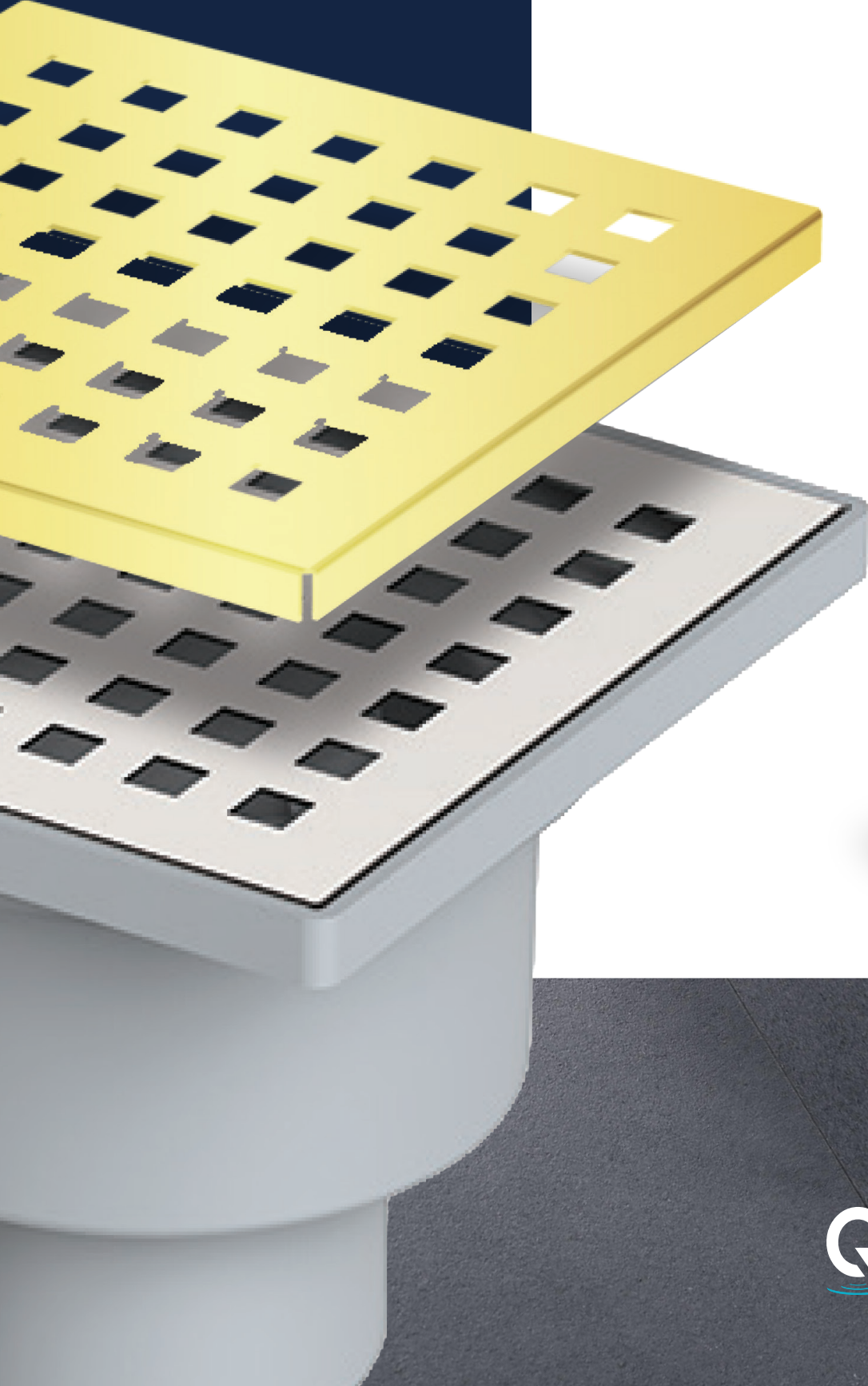

QUAFLUX
FLOOR DRAINERS

www.quaflux.com

VENÜS SERIES

STILL

Line 15x15
Line 20x20

- Banyo Duşu
- Hastane Duşu
- Otel Duşu
- Soyunma Odası Duşu

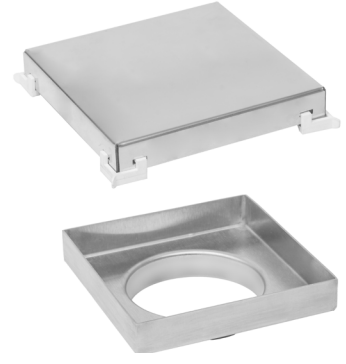
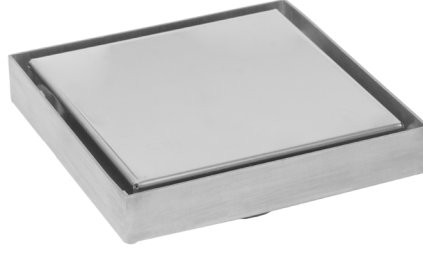

IzgaraRenkleri: ● Gri ● Altın

Kod	Boyut	Çıkış		Hammaddeler
Stl 1001	15x15cm Yatay Çıkış	Ø 100	50	SS304
Stl1002	20x20cm Yatay Çıkış	Ø 100	25	SS304

VENÜS SERIES

STILL BENT

Line 15x15
Line 20x20

- Banyo Duşu
- Hastane Duşu
- Otel Duşu
- Soyunma Odası Duşu

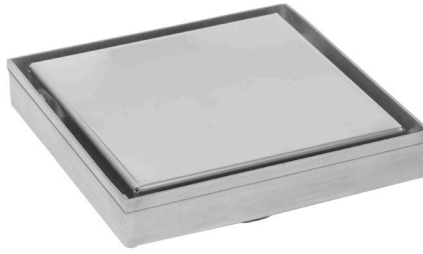

IzgaraRenkleri: ● Gri ● Altın

Kod	Boyut	Çıkış		Hammaddeler
Stlb 1001	15x15cm Yatay Çıkış	Ø 100	50	SS304
Stlb 1002	20x20cm Yatay Çıkış	Ø 100	25	SS304

VENÜS SERIES

WEST

Line 15x15
Line 20x20

- Banyo Duşu
- Hastane Duşu
- Otel Duşu
- Soyunma Odası Duşu



IzgaraRenkleri: ● Gri ● Altın

Kod	Boyut	Çıkış		Hammaddeler
Venüs 1001	15x15cm Yatay Çıkış	Ø 100	25	SS304
Venüs 1002	20x20cm Yatay Çıkış	Ø 100	25	SS304
Venüs 1003	15x15cm Yatay Çıkış	Ø 110	25	SS304
Venüs 1004	20x20cm Yatay Çıkış	Ø 110	25	SS304

VENÜS SERIES

SLIMSTAR

- Banyo Duşu
- Hastane Duşu
- Otel Duşu
- Soyunma Odası Duşu



IzgaraRenkleri: ● Gri ● Altın



Kod	Boyut	Çıkış		Hammaddeler
Venüs 1001	10x10cm Yatay Çıkış	Ø 32	-	SS304

VENÜS SERIES

SMALLINE

- Banyo Duşu
- Hastane Duşu
- Otel Duşu
- Soyunma Odası Duşu



IzgaraRenkleri: ● Gri ● Altın



Kod	Boyut	Çıkış		Hammaddeler
Venüs 1001	10x10cm Yatay Çıkış	Ø 50	-	SS304
Venüs 1002	10x10cm Yatay Çıkış	Ø 32	-	SS304

QUAFLUX

FLOOR DRAINERS



VENÜS SERIES

YER SIFONLARI

Line 15x15
Line 20x20

- Banyo Duşu
- Hastane Duşu
- Otel Duşu
- Soyunma Odası Duşu



IzgaraRenkleri: ● Gri ● Altın

Kod	Açıklama	Ölçü		Hammaddeler
Venüs 1001	Etekli 1.20 / 1.50mm	15x15 cm	160	SS304
Venüs 1002	Eteksiz 1.20 / 1.50mm	15x15 cm	100	SS304
Venüs 1003	Etekli 1.20 / 1.50mm	20x20 cm	160	SS304
Venüs 1004	Eteksiz 1.20 / 1.50mm	20x20 cm	100	SS304

VENÜS SERIES

YER SIFONLARI

Line 15x15
Line 20x20

- Banyo Duşu
- Hastane Duşu
- Otel Duşu
- Soyunma Odası Duşu



IzgaraRenkleri: ● Gri ● Altın

Kod	Açıklama	Ölçü		Hammaddeler
Venüs 1005	Etekli 1.20 / 1.50mm	15x15 cm	160	SS304
Venüs 1006	Eteksiz 1.20 / 1.50mm	15x15 cm	100	SS304
Venüs 1007	Etekli 1.20 / 1.50mm	20x20 cm	160	SS304
Venüs 1008	Eteksiz 1.20 / 1.50mm	20x20 cm	100	SS304

VENÜS SERIES

YER SIFONLARI

Line 15x15
Line 20x20

- Banyo Duşu
- Hastane Duşu
- Otel Duşu
- Soyunma Odası Duşu



IzgaraRenkleri: ● Gri ● Altın

Kod	Açıklama	Ölçü		Hammaddeler
Venüs 1009	Etekli 1.20 / 1.50mm	15x15 cm	160	SS304
Venüs 1010	Eteksiz 1.20 / 1.50mm	15x15 cm	100	SS304
Venüs 1011	Etekli 1.20 / 1.50mm	20x20 cm	160	SS304
Venüs 1012	Eteksiz 1.20 / 1.50mm	20x20 cm	100	SS304

VENÜS SERIES

YER SIFONLARI

Line 15x15
Line 20x20

- Banyo Duşu
- Hastane Duşu
- Otel Duşu
- Soyunma Odası Duşu



IzgaraRenkleri: ● Gri ● Altın

Kod	Açıklama	Ölçü		Hammaddeler
Venüs 1013	Etekli 1.20 / 1.50mm	15x15 cm	160	SS304
Venüs 1014	Eteksiz 1.20 / 1.50mm	15x15 cm	100	SS304
Venüs 1015	Etekli 1.20 / 1.50mm	20x20 cm	160	SS304
Venüs 1016	Eteksiz 1.20 / 1.50mm	20x20 cm	100	SS304

VENÜS SERIES

YER SIFONLARI

Line 15x15
Line 20x20

- Banyo Duşu
- Hastane Duşu
- Otel Duşu
- Soyunma Odası Duşu



IzgaraRenkleri: ● Gri ● Altın

Kod	Açıklama	Ölçü		Hammaddeler
Venüs 1017	Etekli 1.20 / 1.50mm	15x15 cm	160	SS304
Venüs 1018	Eteksiz 1.20 / 1.50mm	15x15 cm	100	SS304
Venüs 1019	Etekli 1.20 / 1.50mm	20x20 cm	160	SS304
Venüs 1020	Eteksiz 1.20 / 1.50mm	20x20 cm	100	SS304

VENÜS SERIES

YER SIFONLARI

Line 15x15
Line 20x20

- Banyo Duşu
- Hastane Duşu
- Otel Duşu
- Soyunma Odası Duşu



IzgaraRenkleri: ● Gri ● Altın

Kod	Açıklama	Ölçü		Hammaddeler
Venüs 1021	Etekli 1.50mm	15x15 cm	160	SS304
Venüs 1022	Eteksiz 1.50mm	15x15 cm	100	SS304
Venüs 1023	Etekli 1.50mm	20x20 cm	160	SS304
Venüs 1024	Eteksiz 1.50mm	20x20 cm	100	SS304

VENÜS SERIES

POINT

Line 5x5

- Banyo Duşu
- Hastane Duşu
- Otel Duşu
- Soyunma Odası Duşu



IzgaraRenkleri: ● Gri ● Altın

Kod	Boyut	Çıkış		Hammaddeler
Venüs 1001	10x10cm Yatay Çıkış	Ø 32	160	SS304

VENÜS SERIES

YER SIFONLARI

Line 15X15

- Banyo Duşu
- Hastane Duşu
- Otel Duşu
- Soyunma Odası Duşu



IzgaraRenkleri: ● Gri ● Altın

Kod	Boyut	Çıkış		Hammaddeler
Venüs 1001	10x10cm Yatay Çıkış	Ø 32	160	SS304
Venüs 1002	10x10cm Yatay Çıkış	Ø 40	100	SS304

we care your bathroom

www.quaflux.com



VENÜS SERIES

**ECO
SMALL**

- Banyo Duşu
- Hastane Duşu
- Otel Duşu
- Soyunma Odası Duşu



IzgaraRenkleri: ● Gri ● Altın

Kod	Boyut	Çıkış		Hammaddeler
Venüs 1001	10x10cm Yatay Çıkış	Ø 32	160	Polipropilen
Venüs 1002	10x10cm Yatay Çıkış	Ø 40	100	Polipropilen
Venüs 1003	10x10cm Yatay Çıkış	Ø 50	100	Polipropilen
Venüs 1004	10x10cm Yatay Çıkış	Ø 70	80	Polipropilen

Kod	Boyut	Çıkış		Hammaddeler
Venüs 1005	10x10cm Dikey Çıkış	Ø 40	140	Polipropilen
Venüs 1006	10x10cm Dikey Çıkış	Ø 50	140	Polipropilen
Venüs 1007	10x10cm Dikey Çıkış	Ø 70	140	Polipropilen

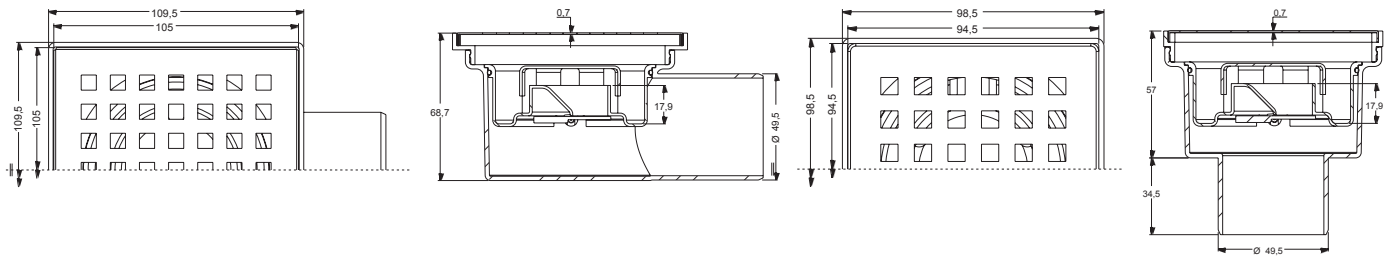

***Plastik Gövde / Paslanmaz Izgara / Su ile Koku Engelleme**

DN 50 Yan ve Alt Çıkış - PVC boru bağlantıları ile uyumludur.
Debi 32 lt/dk'dır. Izgara 304 kalite Paslanmaz çeliktir.
Paslanmaz 304 kalite çelik izgarası sayesinde şık ve kaliteli bir görünüme sahiptir. Duvara monte uygulamalarda kolaylıkla uygulanabilir. Su tutucu koku önleyicisi sayesinde tesisattan kötü kokuların gelmesini engeller. Yükseltme ayakları sayesinde şap yüksekliğine göre ayarlama imkanı sağlar. Organik ve inorganik kimyasallara karşı yüksek dayanım. çoğu asidik ve tuzlu su oksidasyonuna dayanıklıdır.

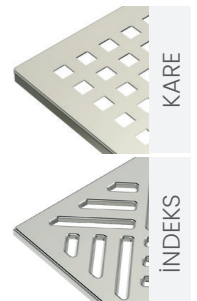

VENÜS SERIES

**ECO
LARGE**

- Banyo Duşu
- Hastane Duşu
- Otel Duşu
- Soyunma Odası Duşu

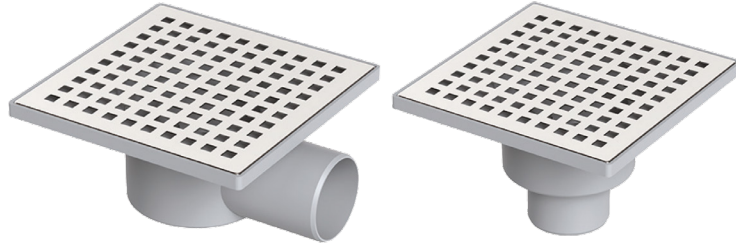

IzgaraRenkleri: ● Gri ● Altın

Kod	Boyut	Çıkış		Hammaddeler
Venüs 1010	15x15cm YatayÇıkış	Ø 32	80	Polipropilen
Venüs 1011	15x15cm YatayÇıkış	Ø 40	60	Polipropilen
Venüs 1012	15x15cm YatayÇıkış	Ø 50	60	Polipropilen
Venüs 1013	15x15cm YatayÇıkış	Ø 70	50	Polipropilen

Kod	Boyut	Çıkış		Hammaddeler
Venüs 1014	15x15cm DikeyÇıkış	Ø 40	60	Polipropilen
Venüs 1015	15x15cm DikeyÇıkış	Ø 50	60	Polipropilen
Venüs 1016	15x15cm DikeyÇıkış	Ø 70	60	Polipropilen

VENÜS SERIES
ECOSTAR

- Banyo Duşu
- Hastane Duşu
- Otel Duşu
- Soyunma Odası Duşu

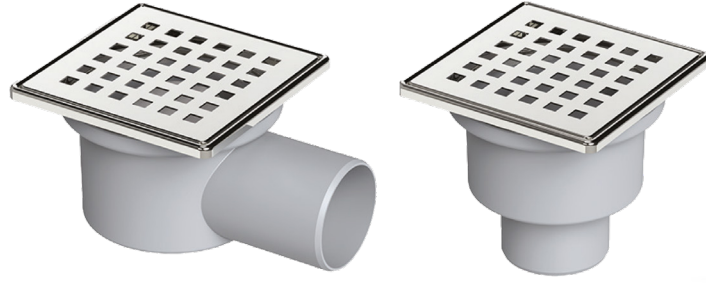

IzgaraRenkleri: ● Gri ● Altın

Kod	Boyut	Çıkış		Hammaddeler
Venus 1019	10x10cm Yatay Çıkış	Ø 32	160	Polipropilen / Paslanmaz
Venus 1020	10x10cm Yatay Çıkış	Ø 40	100	Polipropilen / Paslanmaz
Venus 1021	10x10cm Yatay Çıkış	Ø 50	100	Polipropilen / Paslanmaz
Venus 1022	10x10cm Yatay Çıkış	Ø 70	80	Polipropilen / Paslanmaz

Kod	Boyut	Çıkış		Hammaddeler
Venus 1023	10x10cm Dikey Çıkış	Ø 40	140	Polipropilen / Paslanmaz
Venus 1024	10x10cm Dikey Çıkış	Ø 50	140	Polipropilen / Paslanmaz
Venus 1025	10x10cm Dikey Çıkış	Ø 70	140	Polipropilen / Paslanmaz

Kod	Boyut	Çıkış		Hammaddeler
Venus 1026	10x10cm Prime Line Blister	Ø 32	40	Polipropilen / Paslanmaz
Venus 1027	10x10cm Prime Line Blister	Ø 50	40	Polipropilen / Paslanmaz

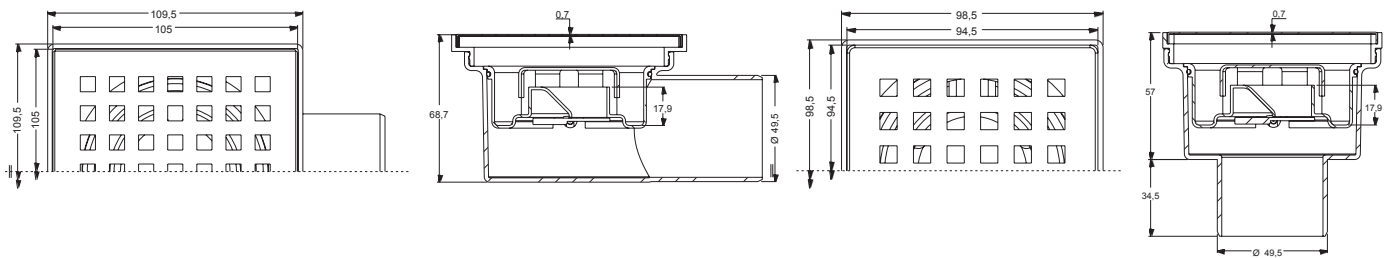

DN 50 Yan ve Alt Çıkış - PVC boru bağlantıları ile uyumludur. Debi 32 lt/dk'dır. Izgara 304 kalite Paslanmaz çeliktir. Paslanmaz 304 kalite çelik izgarası sayesinde şık ve kaliteli bir görünüme sahiptir. Duvara monte uygulamalarda kolaylıkla uygulanabilir. Su tutucu koku önleyicisi sayesinde tesisattan kötü kokuların gelmesini engeller. Yükseltme ayakları sayesinde şap yüksekliğine göre ayarlama imkanı sağlar. Organik ve inorganik kimyasallara karşı yüksek dayanım. çoğu asidik ve tuzlu su oksidasyonuna dayanıklıdır.

- *Plastik Gövde
- *Paslanmaz Izgara
- *Su ile Koku Engelleme

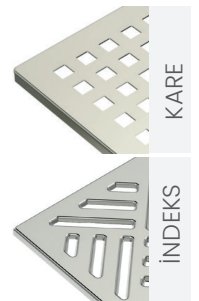

VENÜS SERIES

**ECOSTAR
LARGE**

Line 15x15

- Banyo Duşu
- Hastane Duşu
- Otel Duşu
- Soyunma Odası Duşu

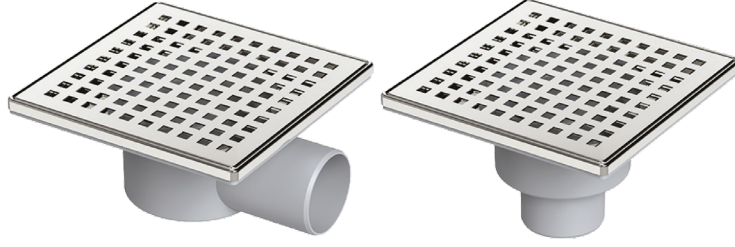

IzgaraRenkleri: ● Gri ● Altın

Kod	Boyut	Çıkış		Hammaddeler
Venüs 1019	10x10cm Yatay Çıkış	Ø 32	160	Polipropilen / Paslanmaz
Venüs 1020	10x10cm Yatay Çıkış	Ø 40	100	Polipropilen / Paslanmaz
Venüs 1021	10x10cm Yatay Çıkış	Ø 50	100	Polipropilen / Paslanmaz
Venüs 1022	10x10cm Yatay Çıkış	Ø 70	80	Polipropilen / Paslanmaz

Kod	Boyut	Çıkış		Hammaddeler
Venüs 1023	10x10cm Dikey Çıkış	Ø 40	140	Polipropilen / Paslanmaz
Venüs 1024	10x10cm Dikey Çıkış	Ø 50	140	Polipropilen / Paslanmaz
Venüs 1025	10x10cm Dikey Çıkış	Ø 70	140	Polipropilen / Paslanmaz

Kod	Boyut	Çıkış		Hammaddeler
Venüs 1026	10x10cm Prime Line Blister	Ø 32	40	Polipropilen / Paslanmaz
Venüs 1027	10x10cm Prime Line Blister	Ø 50	40	Polipropilen / Paslanmaz

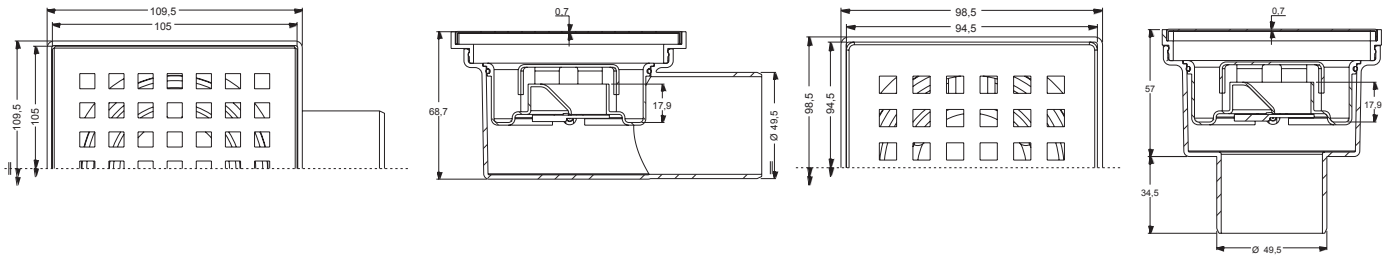

DN 50 Yan ve Alt Çıkış - PVC boru bağlantıları ile uyumludur. Debi 32 lt/dk'dır. Izgara 304 kalite Paslanmaz çeliktir. Paslanmaz 304 kalite çelik izgarası sayesinde şık ve kaliteli bir görünüme sahiptir. Duvara monte uygulamalarda kolaylıkla uygulanabilir. Su tutucu koku önleyicisi sayesinde tesisattan kötü kokuların gelmesini engeller. Yükseltme ayakları sayesinde şap yüksekliğine göre ayarlama imkanı sağlar. Organik ve inorganik kimyasallara karşı yüksek dayanım. çoğu asidik ve tuzlu su oksidasyonuna dayanıklıdır. to most acidic and salt water oxidation.

- *Plastik Gövde
- *Paslanmaz Izgara
- *Su ile Koku Engelleme

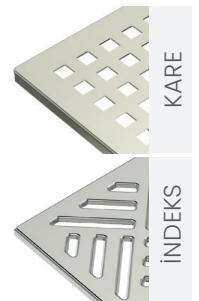

VENUS PLUS+ SERIES
TILESTAR

Paslanmaz 15x15

- Banyo Duşu
- Hastane Duşu
- Otel Duşu
- Soyunma Odası Duşu



IzgaraRenkleri: ● Gri ● Altın

304 STAINLESS
 STEEL

*Paslanmaz Gövde / Paslanmaz Izgara / Su ile Koku Engelleme

Kod	Boyut	Çıkış		Hammaddeler
Venus 1071	15x15cm Seramik Uyumlu	Ø 50	12	Paslanmaz

 VENUS PLUS+ SERIES
**TILESTAR
 LARGE**

Paslanmaz 20x20

- Banyo Duşu
- Hastane Duşu
- Otel Duşu
- Soyunma Odası Duşu



IzgaraRenkleri: ● Gri ● Altın

304 STAINLESS
 STEEL

*Paslanmaz Gövde / Paslanmaz Izgara / Su ile Koku Engelleme

Kod	Boyut	Çıkış		Hammaddeler
Venus 1072	20x20cm Seramik Uyumlu	Ø 50	8	Paslanmaz

QUAFLUX
 FLOOR DRAINERS
we care your bathroom

VENUS PLUS+ SERIES
SLIMSTAR

Paslanmaz 11x11

- Banyo Duşu
- Hastane Duşu
- Otel Duşu
- Soyunma Odası Duşu



IzgaraRenkleri: ● Gri ● Altın



SLIM &
ELEGANT



304 STAINLESS
STEEL

*Paslanmaz Gövde / Paslanmaz Izgara / Su ile Koku Engelleme

Kod	Boyut	Çıkış		Hammaddeler
Venus 1073	11x11cm Yatay Çıkış	Ø 50	48	Paslanmaz

VENUS PLUS+ SERIES
**SLIMSTAR
LARGE**

Paslanmaz 15x15

- Banyo Duşu
- Hastane Duşu
- Otel Duşu
- Soyunma Odası Duşu



IzgaraRenkleri: ● Gri ● Altın



304 STAINLESS
STEEL

*Paslanmaz Gövde / Paslanmaz Izgara / Su ile Koku Engelleme

Kod	Boyut	Çıkış		Hammaddeler
Venus 1074	15x15cm Yatay Çıkış	Ø 50	18	Paslanmaz

QUAFLUX
FLOOR DRAINERS
we care your bathroom

VENÜS SERIES

FLOOR DRAINS

Line 10x10

- Banyo Duşu
- Hastane Duşu
- Otel Duşu
- Soyunma Odası Duşu



*Plastik Gövde / Paslanmaz Izgara / Su ile Koku Engelleme

IzgaraRenkleri: ● Gri ● Altın

Kod	Boyut	Çıkış		Hammaddeler
Venüs 1075	10x10cm	Ø 100	150	Polipropilen / Paslanmaz
Venüs 1076	15x15cm	Ø 100	80	Polipropilen / Paslanmaz

DN 50 Yan ve Alt Çıkış - PVC boru bağlantıları ile uyumludur. Debi 32 lt/dk'dır. Izgara 304 kalite Paslanmaz çeliktir. Paslanmaz 304 kalite çelik ızgarası sayesinde şık ve kaliteli bir görünüme sahiptir. Duvara monte uygulamalarda kolaylıkla uygulanabilir. Su tutucu koku önleyicisi sayesinde tesisattan kötü kokuların gelmesini engeller. Yükseltme ayakları sayesinde şap yüksekliğine göre ayarlama imkanı sağlar. Organik ve inorganik kimyasallara karşı yüksek dayanım. çoğu asidik ve tuzlu su oksidasyonuna dayanıklıdır. to most acidic and salt water oxidation.

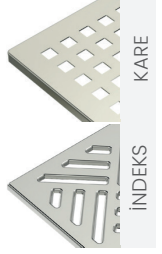

VENÜS SERIES

FLOOR DRAINS

140mm - 180 mm

- Banyo Duşu
- Hastane Duşu
- Otel Duşu
- Soyunma Odası Duşu

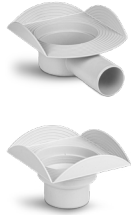

*140 mm ila 200 mm katlanabilir ve ayarlanabilir

IzgaraRenkleri: ● Gri ● Altın

Kod	Boyut	Çıkış		Hammaddeler
Venüs 1081	10x10cm Yatay Çıkış	Ø 32	50	Polipropilen / Paslanmaz
Venüs 1082	10x10cm Yatay Çıkış	Ø 40	50	Polipropilen / Paslanmaz
Venüs 1083	10x10cm Yatay Çıkış	Ø 50	50	Polipropilen / Paslanmaz
Venüs 1084	10x10cm Yatay Çıkış	Ø 70	50	Polipropilen / Paslanmaz
Venüs 1085	10x10cm Yatay Çıkış	Ø 100	50	Polipropilen / Paslanmaz
Venüs 1086	10x10cm Dikey Çıkış	Ø 40	50	Polipropilen / Paslanmaz
Venüs 1087	10x10cm Dikey Çıkış	Ø 50	50	Polipropilen / Paslanmaz
Venüs 1088	10x10cm Dikey Çıkış	Ø 70	50	Polipropilen / Paslanmaz
Venüs 1089	10x10cm Dikey Çıkış	Ø 100	50	Polipropilen / Paslanmaz

VENÜS SERIES

FLOOR DRAINS

140mm - 180 mm

- Banyo Duşu
- Hastane Duşu
- Otel Duşu
- Soyunma Odası Duşu

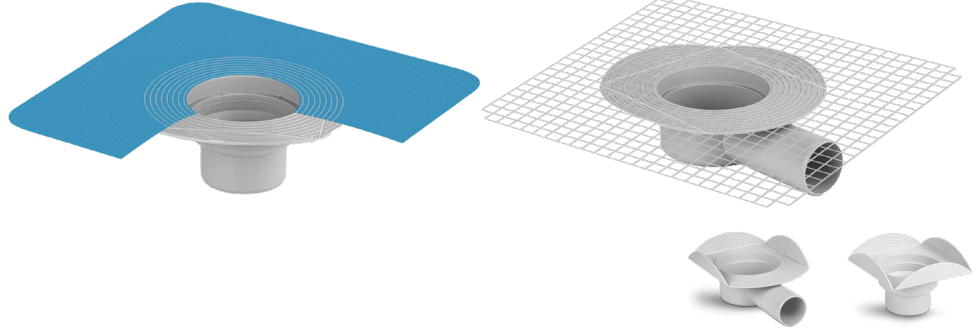

*140 mm ila 200 mm katlanabilir ve ayarlanabilir

IzgaraRenkleri: Gri Altın

Kod	Boyut	Çıkış		Hammaddeler
Venüs 1108	140mm Yatay Çıkış	Ø 32	125	Polipropilen
Venüs 1109	140mm Yatay Çıkış	Ø 40	125	Polipropilen
Venüs 1110	140mm Yatay Çıkış	Ø 50	100	Polipropilen
Venüs 1111	140mm Yatay Çıkış	Ø 70	75	Polipropilen
Venüs 1112	140mm Yatay Çıkış	Ø 100	75	Polipropilen
Venüs 1113	140mm Dikey Çıkış	Ø 40	140	Polipropilen
Venüs 1114	140mm Dikey Çıkış	Ø 50	140	Polipropilen
Venüs 1115	140mm Dikey Çıkış	Ø 70	125	Polipropilen
Venüs 1116	140mm Dikey Çıkış	Ø 100	75	Polipropilen

VENÜS SERIES

KÖŞE BALKON

Line 13x13

Line 16x16

- Banyo Duşu
- Hastane Duşu
- Otel Duşu
- Soyunma Odası Duşu



Kod	Boyut	Çıkış		Hammaddeler
Venüs 1101	13x13cm	Ø 70	-	Polipropilen / Paslanmaz
Venüs 1102	16x16cm	Ø 100	-	Polipropilen / Paslanmaz

VENÜS SERIES

PARAPET

70-100 Parapet

- Banyo Duşu
- Hastane Duşu
- Otel Duşu
- Soyunma Odası Duşu

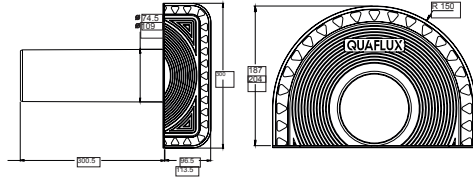

Kod	Boyut	Çıkış		Hammaddeler
Parapet	70 Ø Yatay Çıkış	Ø 70	30	Polipropilen
Parapet	100 Ø Yatay Çıkış	Ø 100	25	Polipropilen

VENÜS SERIES

PARAPET

70-100 Parapet

- Banyo Duşu
- Hastane Duşu
- Otel Duşu
- Soyunma Odası Duşu

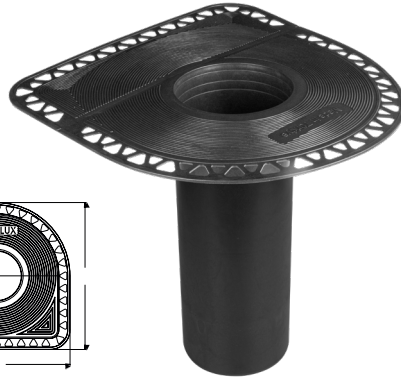
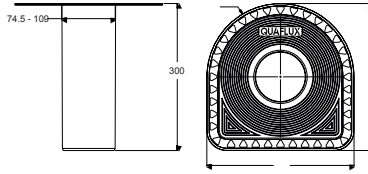

Kod	Boyut	Çıkış		Hammaddeler
Parapet	70 Ø Dikey Çıkış	Ø 70	30	Polipropilen
Parapet	100 Ø Dikey Çıkış	Ø 100	25	Polipropilen

VENÜS SERIES

PARAPET

70-100 Parapet

- Banyo Duşu
- Hastane Duşu
- Otel Duşu
- Soyunma Odası Duşu

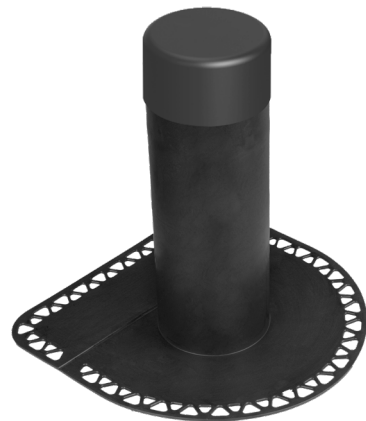
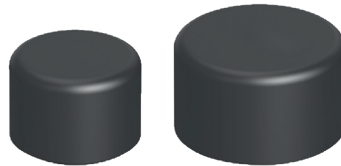

Kod	Boyut	Çıkış		Hammaddeler
Parapet	70 Ø Dikey Çıkış	Ø 70	150	Polipropilen
ParapetCap	Parapet Cover	Ø 100	90	Polipropilen
Parapet	100 Ø Dikey Çıkış	Ø 70	150	Polipropilen
ParapetCap	Parapet Cover	Ø 100	90	Polipropilen

VENÜS SERIES

LEAF HOLDER

70-100 Parapet

- Banyo Duşu
- Hastane Duşu
- Otel Duşu
- Soyunma Odası Duşu

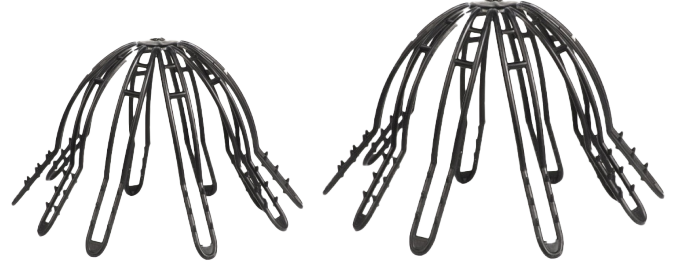
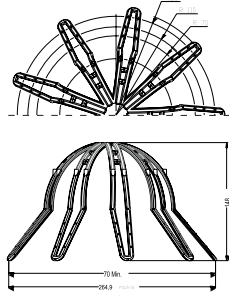

IzgaraRenkleri: ● Gri ● Altın

Kod	Boyut	Çıkış		Hammaddeler
Leaf Holder	Leaf Holder	Ø 70	400	Polipropilen
Leaf Holder	Leaf Holder	Ø 100	175	Polipropilen

QUAFLUX
FLOOR DRAINERS

we care your bathroom

www.quaflux.com

VENÜS SERIES

**YALITIM
UYUMLU
SIFONLAR**

140mm Netleştirilmiş

- Banyo Duşu
- Hastane Duşu
- Otel Duşu
- Soyunma Odası Duşu

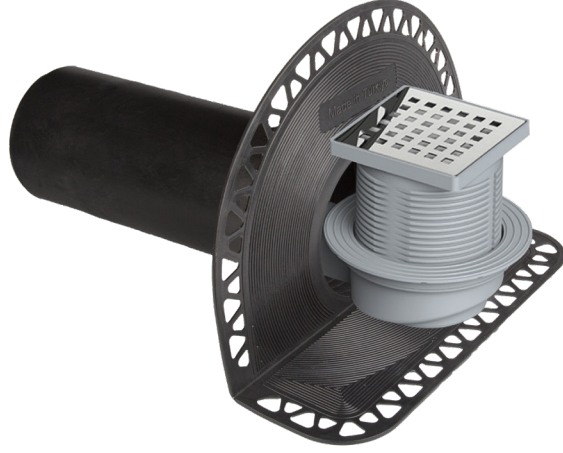

Kod	Boyut	Çıkış		Hammaddeler
Parapet	10x10 Yatay Çıkış	Ø 70	1	Polipropilen
Parapet	10x10 Yatay Çıkış	Ø 100	1	Polipropilen

VENÜS SERIES

**YALITIM
UYUMLU
SIFONLAR**

140mm Netleştirilmiş

- Banyo Duşu
- Hastane Duşu
- Otel Duşu
- Soyunma Odası Duşu



Kod	Boyut	Çıkış		Hammaddeler
Parapet	15x15 Yatay Çıkış	Ø 70	1	Polipropilen
Parapet	15x15 Yatay Çıkış	Ø 100	1	Polipropilen

VENÜS SERIES

YALITIM UYUMLU SIFONLAR

140mm Netleştirilmiş

- Banyo Duşu
- Hastane Duşu
- Otel Duşu
- Soyunma Odası Duşu



Kod	Boyut	Çıkış		Hammaddeler
Parapet	10x10 Dikey Çıkış	Ø 70	1	Polipropilen
Parapet	10x10 Dikey Çıkış	Ø 100	1	Polipropilen

VENÜS SERIES

YALITIM UYUMLU SIFONLAR

140mm Netleştirilmiş

- Banyo Duşu
- Hastane Duşu
- Otel Duşu
- Soyunma Odası Duşu



Kod	Boyut	Çıkış		Hammaddeler
Parapet	15x15 Dikey Çıkış	Ø 70	1	Polipropilen
Parapet	15x15 Dikey Çıkış	Ø 100	1	Polipropilen



The background of the advertisement is a close-up photograph of a metal floor drain grate. The grate is made of a dark, possibly stainless steel or aluminum, material with a series of parallel, elongated slots. It is set into a light-colored, textured concrete or stone floor. The lighting is dramatic, with strong shadows and highlights that emphasize the texture of the grate and the floor. The overall color palette is dark and moody, with the white text providing a stark contrast.

QUAFLUX
FLOOR DRAINERS

DRENAJ KANALI

we care your bathroom

www.quaflux.com

TITAN SERİSİ

DRENAJ KANALI

70x500 mm

- Stadyum,
- Spor Kompleksleri,
- Garaj ve Otopark Girişleri,
- Havuz tarafları,
- Bahçe Kenarları,
- Yürüyüş Yolları,
- Sağlık ve Kamp Alanları



Dışarı:
50mm

↓ **5kN**
Yük Kapasitesi

Renkler: ● Siyah ● Gri

Kod	Boyut	Yükseklik		Hammaddeler	Ağırlık	Kutu Ağırlığı
Titan 1001	70 x 500mm Kanal	75 mm	-	Polipropilen	300 gr	-
Titan 1002	70 x 500mm Alt Çıkış	75 mm	-	Polipropilen	300 gr	-
Titan 1001-S	70 x 500mm Kanal	75 mm	-	Polipropilen	300 gr	-
Titan 1002-S	70 x 500mm Alt Çıkış	75 mm	-	Polipropilen	300 gr	-

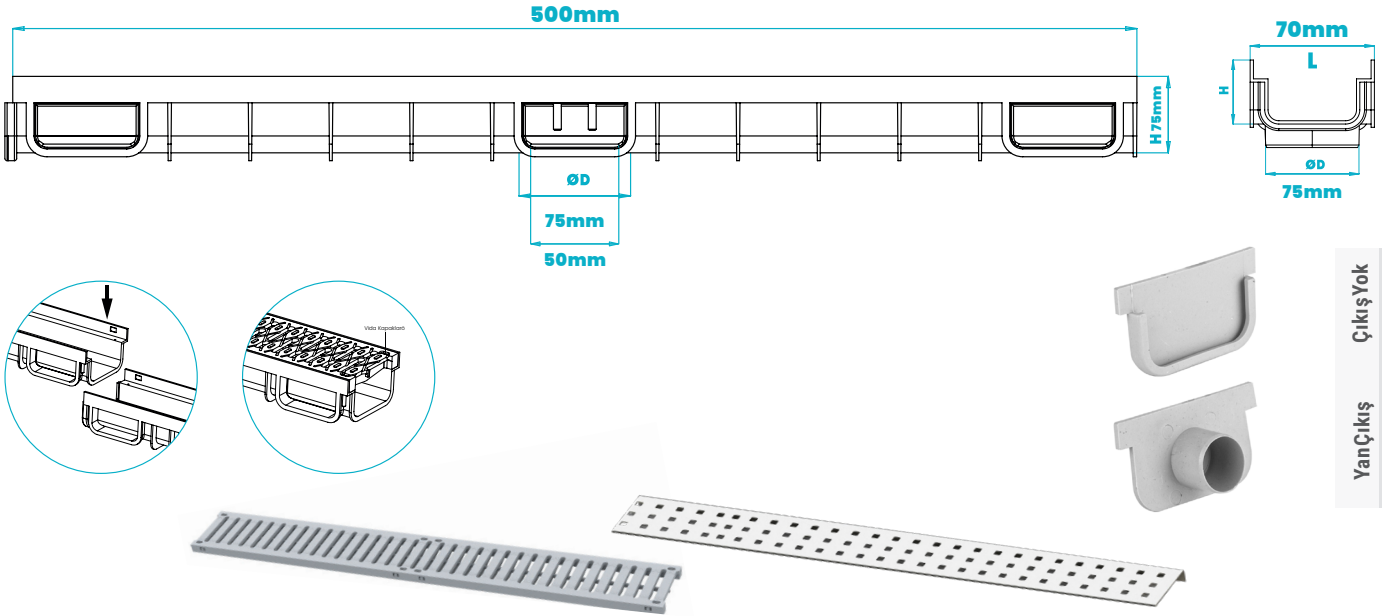

Yan Çıkış Çıkış Yok

IZGARA 70x500 mm
DRENAJ KANALLARI

Türkiye

Kod	Boyut	Ağırlık	Kalite	
Titan 1003	70 x 500mm Izgara	195 gr	Polipropilen	36
Titan 1003-S	70 x 500mm Izgara	195 gr	Polipropilen	36
Titan 1004	70 x 500mm Kapak	15 gr	Polipropilen	150
Titan 1004-S	70 x 500mm Kapak	15 gr	Polipropilen	150
Titan 1060	70 x 500mm Izgara	250 gr	S.S.304 Paslanmaz Çelik	36
Titan 1061	70 x 500mm Kapak	250 gr	Galvanizli Sac	36

TITAN SERİSİ

DRENAJ KANALI

100x500 mm

- Stadyum,
- Spor Kompleksleri,
- Garaj ve Otopark Girişleri,
- Havuz tarafları,
- Bahçe Kenarları,
- Yürüyüş Yolları,
- Sağlık ve Kamp Alanları



5,4 kN
Yük Kapasitesi

Renkler: ● Siyah ● Gri

Dışarı:
50mm

Kod	Boyut	Yükseklik		Hammaddeler	Ağırlık	Kutu Ağırlığı
Titan 1005	100 x 500mm Kanal	75 mm	70	Polipropilen	345 gr	24 Kg
Titan 1005-S	100 x 500mm Alt Çıkış	75 mm	40	Polipropilen	345 gr	14 Kg
Titan 1006	100 x 500mm Kanal	75 mm	70	Polipropilen	345 gr	24 Kg
Titan 1006-S	100 x 500mm Alt Çıkış	75 mm	40	Polipropilen	345 gr	14 Kg

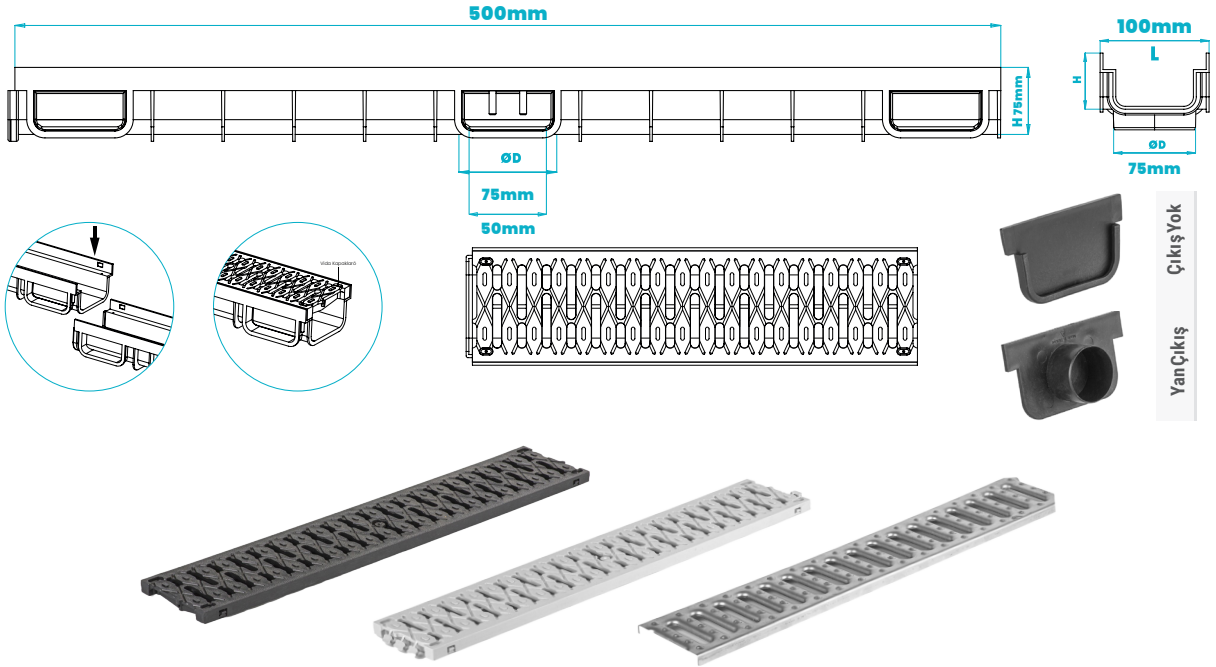

IZGARA 100x500 mm
DRENAJ KANALLARI

Türkiye

Kod	Boyut	Ağırlık	Kaliteli	
Titan 1007	100 x 500mm Izgara	215 gr	Polipropilen	65
Titan 1008	100 x 500mm Izgara	430 gr	S.S.304 Paslanmaz Çelik	65
Titan 1009	100 x 500mm Izgara	430 gr	Galvanizli Sac	65
Titan 1010	100 x 500mm Kapak	15 gr	Polipropilen	150
Titan 1007-S	100 x 500mm Izgara	215 gr	Polipropilen	65
Titan 1010-S	100 x 500mm Kapak	15 gr	Polipropilen	150

TITAN SERİSİ

DRENAJ KANALI

130x500 mm

- Stadyum,
- Spor Kompleksleri,
- Garaj ve Otopark Girişleri,
- Havuz tarafları,
- Bahçe Kenarları,
- Yürüyüş Yolları,
- Sağlık ve Kamp Alanları

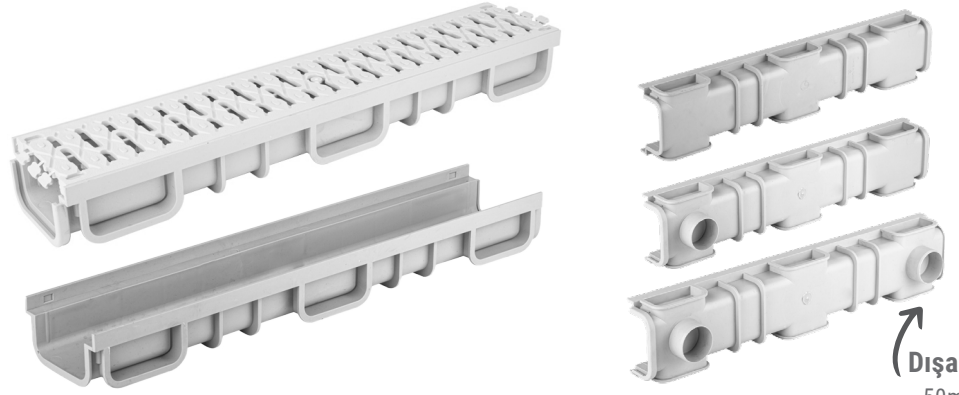

Dışarı:
50mm

↓ **11,4 kN**
Yük Kapasitesi

Renkler: ● Siyah ● Gri

Kod	Boyut	Yükseklik		Hammaddeler	Ağırlık	Kutu Ağırlığı
Titan 1011	130 x 500mm Kanal	75 mm	32	Polipropilen	555 gr	18 Kg
Titan 1011-S	130 x 500mm Alt Çıkış	75 mm	48	Polipropilen	555 gr	27 Kg
Titan 1012	130 x 500mm Kanal	75 mm	32	Polipropilen	555 gr	18 Kg
Titan 1012-S	130 x 500mm Alt Çıkış	75 mm	48	Polipropilen	555 gr	27 Kg

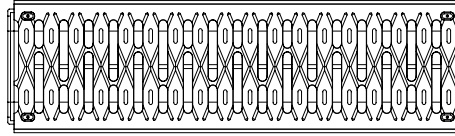
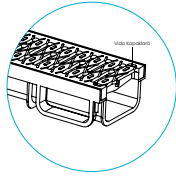
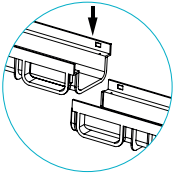
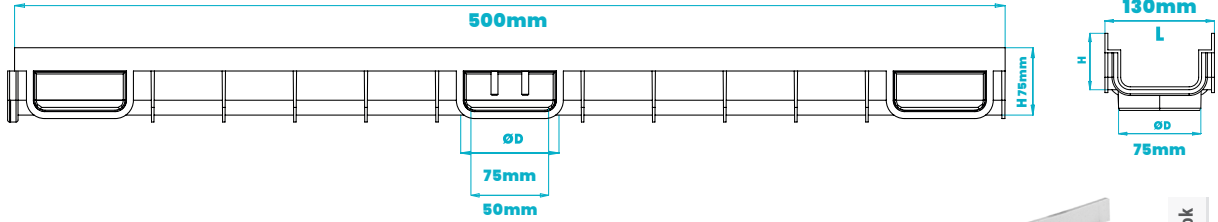

Yan Çıkış Çıkış Yok

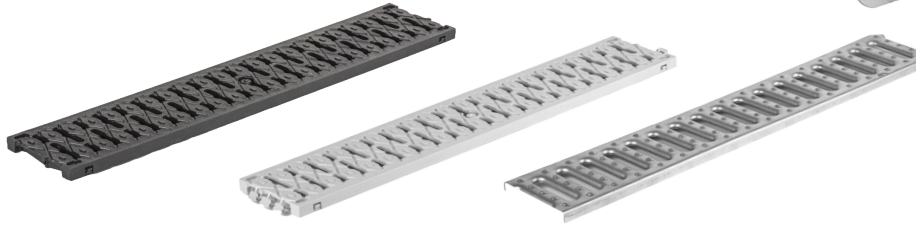

IZGARA 130x500 mm
DRENAJ KANALLARI

Türkiye

Kod	Boyut	Ağırlık	Kaliteli	
Titan 1013	125 x 500mm Izgara	370 gr	Polipropilen	65
Titan 1014	125 x 500mm Izgara	840 gr	S.S.304 Paslanmaz Çelik	65
Titan 1015	125 x 500mm Izgara	840 gr	Galvanizli Sac	65
Titan 1016 Kapak	125 x 500mm Kapak	15 gr	Polipropilen	150
Titan 1013-S	125 x 500mm Izgara	370 gr	Polipropilen	65
Titan 1016-S Kapak	125 x 500mm Kapak	15 gr	Polipropilen	150

TITAN SERİSİ

DRENAJ KANALI

200x500 mm

- Stadyum,
- Spor Kompleksleri,
- Garaj ve Otopark Girişleri,
- Havuz tarafları,
- Bahçe Kenarları,
- Yürüyüş Yolları,
- Sağlık ve Kamp Alanları

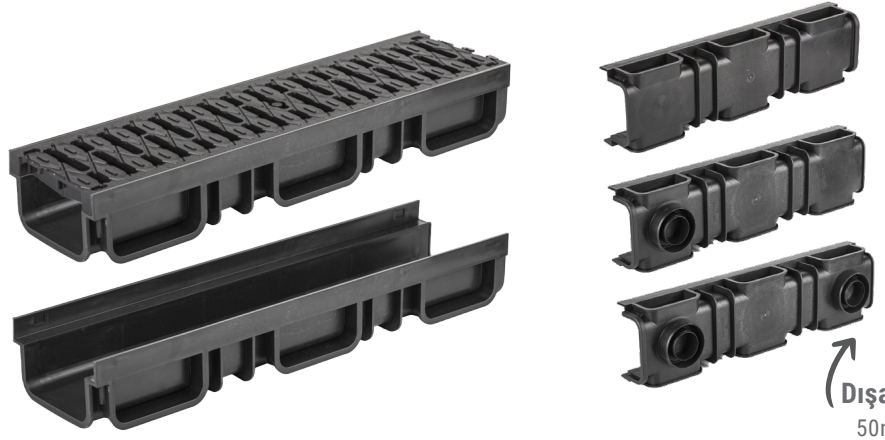

Dışarı:
50mm

↓ **14,8 kN**
Yük Kapasitesi

Renkler: ● Siyah ● Gri

Kod	Boyut	Yükseklik		Hammaddeler	Ağırlık	Kutu Ağırlığı
Titan 1017	200 x 500mm Kanal	75 mm	20	Polipropilen	940 gr	19 Kg
Titan 1017-S	200 x 500mm Alt Çıkış	75 mm	16	Polipropilen	940 gr	15 Kg
Titan 1018	200 x 500mm Kanal	75 mm	20	Polipropilen	940 gr	19 Kg
Titan 1018-S	200 x 500mm Alt Çıkış	75 mm	16	Polipropilen	940 gr	15 Kg

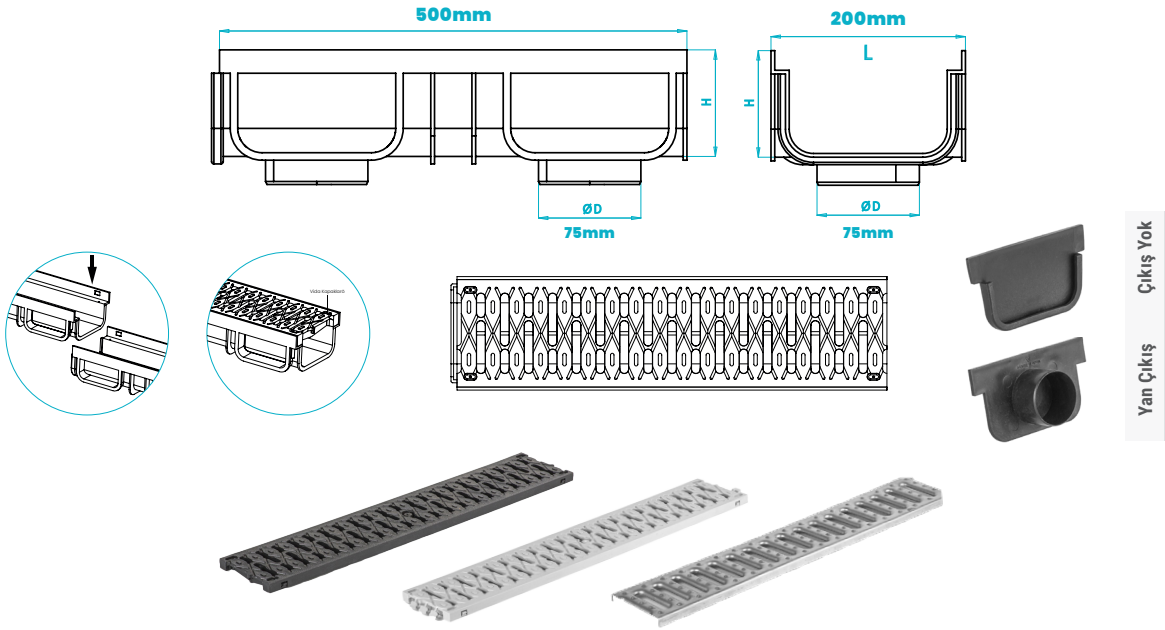

GRID 200x500 mm
DRENAJ KANALLARI

Türkiye

Kod	Boyut	Ağırlık	Kalite	
Titan 1019	195 x 500mm Izgara	670 gr	Polipropilen	65
Titan 1020	195 x 500mm Izgara	1.500 gr	S.S.304 Paslanmaz Çelik	65
Titan 1021	195 x 500mm Izgara	1.500 gr	Galvanizli Sac	65
Titan 1022 Kapak	195 x 500mm Kapak	15 gr	Polipropilen	150
Titan 1019-S	195 x 500mm Izgara	670 gr	Polipropilen	65
Titan 1022-S Kapak	195 x 500mm Kapak	15 gr	Polipropilen	150

TITAN SERİSİ

DRENAJ KANALI

130x1000 mm

- Stadyum,
- Spor Kompleksleri,
- Garaj ve Otopark Girişleri,
- Havuz tarafları,
- Bahçe Kenarları,
- Yürüyüş Yolları,
- Sağlık ve Kamp Alanları



Dışarı:
50mm

↓ **11,4 kN**
Yük Kapasitesi

Renkler: ● Siyah ● Gri

Kod	Boyut	Yükseklik		Hammaddeler	Ağırlık	Kutu Ağırlığı
Titan 1023	130 x 1000mm Kanal	75 mm	20	Polipropilen	1090 gr	22 Kg
Titan 1023-S	130 x 1000mm Alt Çıkış	75 mm	20	Polipropilen	1090 gr	22 Kg
Titan 1024	130 x 1000mm Kanal	75 mm	20	Polipropilen	1090 gr	22 Kg
Titan 1024-S	130 x 1000mm Alt Çıkış	75 mm	20	Polipropilen	1090 gr	22 Kg

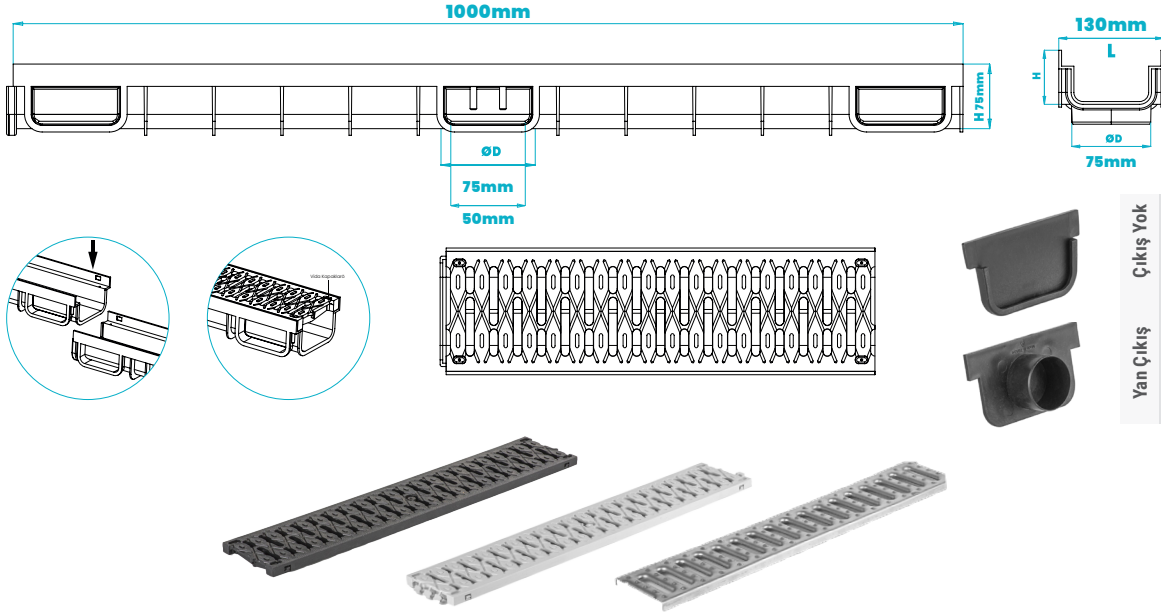

Çıkış Yok
Yan Çıkış

GRID 130x1000 mm
DRENAJ KANALLARI

Türkiye

Kod	Boyut	Ağırlık	Kalite	
Titan 1025	125 x 1000mm Izgara	800 gr	Polipropilen	65
Titan 1026	125 x 1000mm Izgara	1.650 gr	S.S.304 Paslanmaz Çelik	65
Titan 1027	125 x 1000mm Izgara	1.650 gr	Galvanizli Sac	65
Titan 1028 Kapak	125 x 1000mm Kapak	15 gr	Polipropilen	150
Titan 1025-S	125 x 1000mm Izgara	800 gr	Polipropilen	65
Titan 1028-S Kapak	125 x 1000mm Kapak	80 gr	Polipropilen	150

VENÜS SERIES

SIPHONE & MANHOLE

20x20 mm
25x25 mm

- Stadyum,
- Spor Kompleksleri,
- Garaj ve Otopark Girişleri,
- Havuz tarafları,
- Bahçe Kenarları



Kod	Boyut		Hammaddeler
Titan 1053	20x20 Alt ve Yan Çıkış	20	Polipropilen
Titan 1054	20x20 Alt ve Yan Çıkış	20	Polipropilen
Titan 1055	25x25 Alt ve Yan Çıkış	20	Polipropilen
Titan 1056	25x25 Alt ve Yan Çıkış	20	Polipropilen

VENÜS SERIES

SIPHONE & MANHOLE

22x22 mm | 39x39 mm
33x33 mm

- Stadyum,
- Spor Kompleksleri,
- Garaj ve Otopark Girişleri,
- Havuz tarafları,
- Bahçe Kenarları



Kod	Boyut		Hammaddeler
Titan 1057	22x22cm Plastik Rögar Kapağı	20	Polipropilen
Titan 1058	33x33cm Plastik Rögar Kapağı	20	Polipropilen
Titan 1059	39x39cm Plastik Rögar Kapağı	20	Polipropilen

QUAFLUX

FLOOR DRAINERS

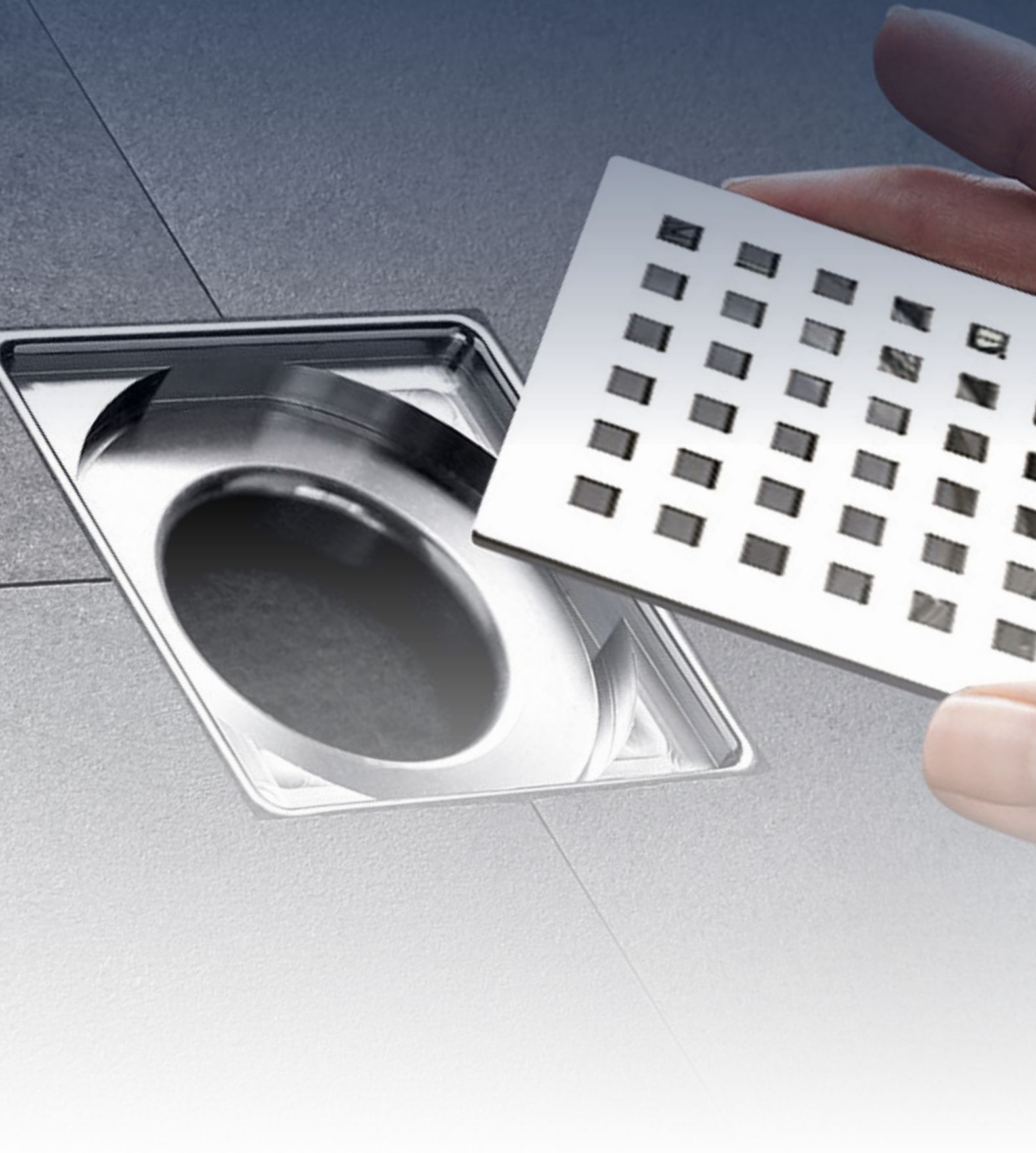

AURA SERİSİ

**RÖGAR
KAPAĞI**

20 / 30 / 40 / 50 / 60 / 80

- Banyo Duşu
- Hastane Duşu
- Otel Duşu
- Soyunma Odası Duşu

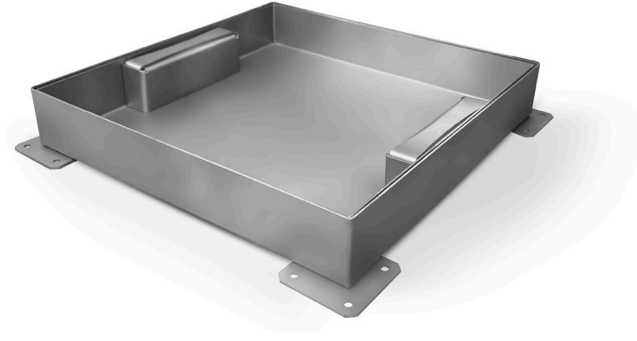

*Plastik Gövde / Paslanmaz Izgara / Su ile Koku Engelleme

PASLANMAZ GÖVDE - PASLANMAZ ÇERÇEVE

Kod	Genişlik	Kutu sayısı
FTM-130-40	30 x 30 cm	1
FTM-140-40	40 x 40 cm	1
FTM-150-40	50 x 50 cm	1
FTM-160-40	60 x 60 cm	1
FTM-170-40	70 x 70 cm	1
FTM-180-40	80 x 80 cm	1



AKSESUARLAR

BORU GİZLEME



Kod	Renkler	Çıkış		Hammaddeler
Acs 1001	Krom	Ø 2 / Ø 7-10	500	Polipropilen
Acs 1002	Beyaz	Ø 2 / Ø 7-10	500	Polipropilen

AKSESUARLAR

BORU KAPAMA ROZETİ TEKLİ



Kod	Renkler	Çıkış		Hammaddeler
Acs 1001	Krom	Ø 2 / Ø 7-10	500	Polipropilen
Acs 1002	Beyaz	Ø 2 / Ø 7-10	500	Polipropilen

AKSESUARLAR

SABİT HAVLU ROZETİ



Kod	Renkler	Çıkış		Hammaddeler
Acs 1003	Krom	Ø 2 / Ø 7-10	600	Polipropilen
Acs 1004	Beyaz	Ø 2 / Ø 7-10	600	Polipropilen

AKSESUARLAR

PANEL MONTAJ BRAKETİ



Kod	Renkler	Çıkış		Hammaddeler
Acs 1007	Boyalı	30 / 40 / 50 / 60 / 90 cm	50	Polipropilen / Çelik



CERTIFICATE

ÇETİNLER PAZARLAMA METAL İMALAT SANAYİ VE DIŞ TİCARET LİMİTED ŞİRKETİ

ESENTEPE MAH. 2954. SK. KÜÇÜK SANAYİ SİTESİ 12 BLOK NO: 36 A SULTANGAZI/ İSTANBUL

KAPSAM : PLASTİKTEN ISLAK HACİM GİDERLERİ VE BANYO AKSESUARLARI ÜRETİMİ

SCOPE: PRODUCTION OF WET DRAINS AND BATHROOM ACCESSORIES FROM PLASTIC

TS ISO 10002:2014

MÜŞTERİ MEMNUNİYETİ YÖNETİM SİSTEMİ (CUSTOMER SATISFACTION MANAGEMENT SYSTEM)

Kurduğunu ve uyguladığını belgelemekte ve EKOL tarafından gerçekleştirilen denetim bu yönetim sisteminin yukarıda belirtilen standardın şartlarını karşıladığını doğrulamaktadır.

It certifies that it is established and implemented, and the audit performed by EKOL it confirms that this management system meets the requirements of the following standard.

Sertifika Numarası / Certificate Number : 9101928940
Sertifika Kodu / Certificate Code : ÇETİNLER
Sertifika Yayın Tarihi / Certificate Issue Date : 19.01.2024
Sertifika Geçerlilik Tarihi / Certificate Validity Date : 19.01.2025
Sertifika Periyodu / Certificate Period : 1 Yıl / 1 Year



002443

Ekol Belgeleme Şirketi

Maslak Mah. Maslak Meydan Sokak Beybi Giz Plaza No.1 Kat.15 D.55
Sarıyer / İstanbul / Türkiye Tel. +90 212 909 12 07 www.ekolbelgeleme.com

Belgenin geçerlilik durumu <https://www.ekolbelgeleme.com/sertifikaara/> adresinden kontrol edilebilir.

www.ekolbelgeleme.com

QUAFLUX
FLOOR DRAINS

Since 1987



CERTIFICATE

ÇETİNLER PAZARLAMA METAL İMALAT SANAYİ VE DIŞ TİCARET LİMİTED ŞİRKETİ

ESENTEPE MAH. 2954. SK. KÜÇÜK SANAYİ SİTESİ 12 BLOK NO: 36 A SULTANGAZI/ İSTANBUL

KAPSAM : PLASTİKTEN ISLAK HACİM GİDERLERİ VE BANYO AKSESUARLARI ÜRETİMİ

SCOPE: PRODUCTION OF WET DRAINS AND BATHROOM ACCESSORIES FROM PLASTIC

ISO 14001:2015 ÇEVRE YÖNETİM SİSTEMİ (ENVIRONMENTAL MANAGEMENT SYSTEM)

Kurduğunu ve uyguladığını belgelemekte ve EKOL tarafından gerçekleştirilen denetim bu yönetim sisteminin yukarıda belirtilen standardın şartlarını karşıladığını doğrulamaktadır.

It certifies that it is established and implemented, and the audit performed by EKOL it confirms that this management system meets the requirements of the following standard.

Sertifika Numarası / Certificate Number	: 9101928941
Sertifika Kodu / Certificate Code	: ÇETİNLER
Sertifika Yayın Tarihi / Certificate Issue Date	: 19.01.2024
Sertifika Geçerlilik Tarihi / Certificate Validity Date	: 19.01.2025
Sertifika Periyodu / Certificate Period	: 1 Yıl / 1 Year



Ekol Belgelendirme Şirketi

002444

Maslak Mah. Maslak Meydan Sokak Beybi Giz Plaza No.1 Kat.15 D.55
Sarıyer / İstanbul / Türkiye Tel. +90 212 909 12 07 www.ekolbelgelendirme.com

Belgenin geçerlilik durumu <https://www.ekolbelgelendirme.com/sertifikaara/> adresinden kontrol edilebilir.

www.ekolbelgelendirme.com

QUAFLUX
FLOOR DRAINAGE

Since 1987



CERTIFICATE

ÇETİNLER PAZARLAMA METAL İMALAT SANAYİ VE DIŞ TİCARET LİMİTED ŞİRKETİ

ESENTEPE MAH. 2954. SK. KÜÇÜK SANAYİ SİTESİ 12 BLOK NO: 36 A SULTANGAZI/ İSTANBUL

KAPSAM : PLASTİKTEN ISLAK HACİM GİDERLERİ VE BANYO AKSESUARLARI ÜRETİMİ

SCOPE: PRODUCTION OF WET DRAINS AND BATHROOM ACCESSORIES FROM PLASTIC

ISO 45001:2018

İŞ SAĞLIĞI VE GÜVENLİĞİ YÖNETİM SİSTEMİ (OCCUPATIONAL HEALTH AND SAFETY MANAGEMENT SYSTEM)

Kurduğunu ve uyguladığını belgelemekte ve EKOL tarafından gerçekleştirilen denetim bu yönetim sisteminin yukarıda belirtilen standardın şartlarını karşıladığını doğrulamaktadır.

It certifies that it is established and implemented, and the audit performed by EKOL it confirms that this management system meets the requirements of the following standard.

Sertifika Numarası / Certificate Number : 9101928942
Sertifika Kodu / Certificate Code : ÇETİNLER
Sertifika Yayın Tarihi / Certificate Issue Date : 19.01.2024
Sertifika Geçerlilik Tarihi / Certificate Validity Date : 19.01.2025
Sertifika Periyodu / Certificate Period : 1 Yıl / 1 Year



Ekol Belgelendirme Şirketi

Maslak Mah. Maslak Meydan Sokak Beybi Giz Plaza No.1 Kat.15 D.55
Sarıyer / İstanbul / Türkiye Tel. +90 212 909 12 07 www.ekolbelgelendirme.com

Belgenin geçerlilik durumu <https://www.ekolbelgelendirme.com/sertifikaara/> adresinden kontrol edilebilir.

002445

www.ekolbelgelendirme.com

QUAFLUX
FLOOR DRAINS

Since 1987



CERTIFICATE



DECLARATION OF CONFORMITY

MANUFACTURER

NAME : ÇETİNLER PAZARLAMA METAL İMALAT SANAYİ VE DİŐ TİCARET LİMİTED ŞİRKETİ

ADDRESS : ESENTEPE MAH. 2954. SK. KÜÇÜK SANAYİ SİTESİ 12 BLOK NO: 36 A SULTANGAZI/ İSTANBUL

Teslim edilen versiyonumuzda aşağıda açıklanan ürünün, tarafımızca piyasaya sürüldüğü şekilde, tasarımı ve tipine göre 2001/95/AT GENEL ÜRÜN DİREKTİFİ ne dayanan uygun temel güvenlik ve sağlık gereksinimlerine uygundur. Tarafımızca kararlaştırılan bu üründe değişiklik yapılması durumunda bu beyan geçerliliğini yitirecektir.

The product described below in our delivered version, as placed on the market by us, complies with the appropriate essential safety and health requirements based on the GENERAL PRODUCT DIRECTIVE 2001/95/EC by design and type. This declaration will lose its validity if changes are made to this product as agreed by us.

PRODUCT NAME:

SİFONLU ZEMİN OLUKLARI, YER SÜZGEÇLERİ

PRODUCT BRAND:

QUAFLUX

RELATED DIRECTIVES:

2001/95/EC GENERAL PRODUCT SAFETY DIRECTIVE

Regulations Applied according to HARMONIZE STANDARDS:

ISO 9001, ISO 14001

CLASSIFICATIONS : CLASS
CERTIFICATE NUMBER : 202018676
CERTIFICATE CODE : ÇETİNLER
CERTIFICATE ISSUE DATE : 19.01.2024
CERTIFICATE VALIDITY DATE : 19.01.2025



002443

Ekol Belgelendirme Şirketi

Maslak Mah. Maslak Meydan Sokak Beybi Giz Plaza No.1 Kat.15 D.55
Sarıyer / İstanbul / Türkiye Tel. +90 212 909 12 07 www.ekolbelgelendirme.com
Belgenin geçerlilik durumu <https://www.ekolbelgelendirme.com/sertifikaara/> adresinden kontrol edilebilir.

www.ekolbelgelendirme.com

QUAFLUX
FLOOR DRAINAGE

Since 1987



CERTIFICATE

ÇETİNLER PAZARLAMA METAL İMALAT SANAYİ VE DİŞ TİCARET LİMİTED ŞİRKETİ

ESENTEPE MAH. 2954. SK. KÜÇÜK SANAYİ SİTESİ 12 BLOK NO: 36 A SULTANGAZI/ İSTANBUL

KAPSAM : PLASTİKTEN ISLAK HACİM GİDERLERİ VE BANYO AKSESUARLARI ÜRETİMİ

SCOPE: PRODUCTION OF WET DRAINS AND BATHROOM ACCESSORIES FROM PLASTIC

TS EN ISO 9001:2015 KALİTE YÖNETİM SİSTEMİ (QUALITY MANAGEMENT SYSTEM)

Kurduğunu ve uyguladığını belgelemekte ve EKOL tarafından gerçekleştirilen denetim bu yönetim sisteminin yukarıda belirtilen standardın şartlarını karşıladığını doğrulamaktadır.

It certifies that it is established and implemented, and the audit performed by EKOL it confirms that this management system meets the requirements of the following standard.

Sertifika Numarası / Certificate Number : 9101928939
Sertifika Kodu / Certificate Code : ÇETİNLER
Sertifika Yayın Tarihi / Certificate Issue Date : 19.01.2024
Sertifika Geçerlilik Tarihi / Certificate Validity Date : 19.01.2025
Sertifika Periyodu / Certificate Period : 1 Yıl / 1 Year



Ekol Belgelendirme Şirketi

Maslak Mah. Maslak Meydan Sokak Beybi Giz Plaza No.1 Kat.15 D.55
Sarıyer / İstanbul / Türkiye Tel. +90 212 909 12 07 www.ekolbelgelendirme.com

Belgenin geçerlilik durumu <https://www.ekolbelgelendirme.com/sertifikaara/> adresinden kontrol edilebilir.

002442

www.ekolbelgelendirme.com

QUAFLUX
FLOOR DRAINS

Since 1987

QUAFLUX

FLOOR DRAINERS

we care your bathroom

Quaflux bir



FURKAN GROUP ' markasıdır.
"WE PRODUCE FOR YOU"



Hakkımızda detaylı bilgi sahibi olmak ve bizi daha yakından tanımak için **QR Kodunu Tarayabilirsiniz.**

İstanbul Fabrika Adresimiz:

Sultangazi Küçük Sanayi Sitesi 2951 Sok. 1.Blok 7/8 Sultangazi / İSTANBUL

Çankırı Fabrika Adresimiz:

Çerkeş Organize Sanayi Bölgesi Organize Sanayi Sitesi - Çerkeş / ÇANKIRI

Rusya Ofis İletişim Bilgileri:

Наше торговое представительство в России в городах Москва и Краснодар. Контакты по телефонам, а также **WhatsApp: 8-918-399-0542 (Москва), 8-964-909-8588 (Краснодар)**

Telefon:

+90 212 668 99 39

Mail:

export@furkanmetalkimya.com

www.quaflux.com